



AQS (Air Quality System) User Guide

2022

Issue 6

This User Guide is designed to familiarize the user with:

- The look and feel of AQS
- Running AQS
- Batch Loading data
- Creating and modifying site and monitor descriptive information
- Generating output information encompassing user data

Note] screen images may vary depending on the user’s operating system and browser.

Contents

Table of Contents

This User Guide is designed to familiarize the user with:.....	1
Contents	1
AQS at a Glance	4
Screen Layout	4
Icons.....	5
Menu Bar, Form Area, and Tabs	6
Status Bar.....	6
List of Values (LOV).....	7
Exchange Network Service Center (ENSC) at a Glance	10
Screen Layout	10
Logging On.....	11
Session Screen	12
User Profile.....	13
Maintain Security	16
Maintain Security Reference Tables.....	16
Site ID Format	17
State Code.....	17
County Code	17
Tribal Code	17
Site Number	17
Batch Submission of Data	17
Understanding of Batch Submission of Data – Training Video	17

Batch Data Submission Overview	17
Using the ENSC.....	19
Loading Files Using AQS.....	27
Type of Data in AQS	37
Transaction Formats	39
Data Codes.....	39
Production Level Data.....	40
Correct	42
Correct Overview	42
Correct Monitor Agency Roles.....	44
Correct Monitor Collocations.....	44
Correct Monitor Objectives.....	44
Correct Monitor Regulation Compliances.....	44
Correct Monitor Tangent Roads	45
Correct Monitor Types	45
Correct Monitor	45
Correct Probe Obstructions	45
Correct Sample Periods	46
Correct Sample Schedules.....	46
Correct Site	46
Correct Open Paths.....	46
Correct Site Tangent Road	47
Correct Raw Data	47
Correct One-Point QC	53
Correct Composite Data	54
Correct Highlights	55
Submitting Corrected Data	55
On-Line Data Tools – Maintain.....	55
Maintain Overview	55
Maintain Site.....	57
Maintain Site	65
Adding Events via Maintain	76

Maintain Event	76
Flag Values with Event Qualifiers.....	78
Defining an Exceptional Event.....	83
Add concurrence flag.....	89
Maintain Cylinder	94
Setting up and mapping monitors to samplers and sampler channels	97
Delete Obsolete Records	107
Data Reports	108
List of Standard Reports	108
Generating Reports	110
Standard Reports Overview.....	110
Standard Reports Form.....	110
Running a Report.....	115
California Dump Bucket.....	116
Form Security	116
Form Operation.....	116
Output	116
Logging Off.....	116
Learn more, service, and support.....	117
Appendix A.....	118
Quick Reference Guide	118

AQS at a Glance

Screen Layout

This portion of the guide describes the parts of the AQS application screen.

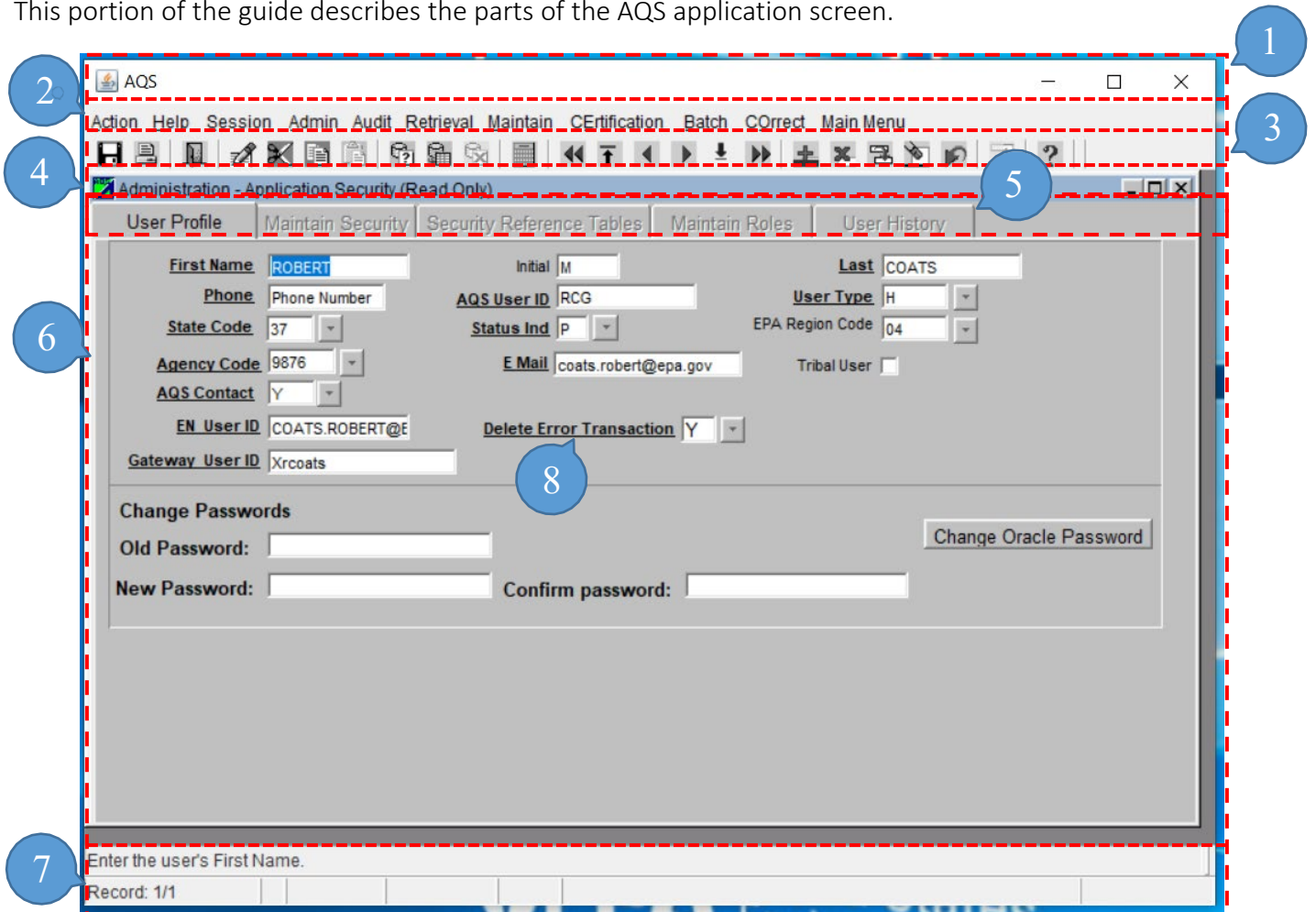

1. AQS Title Bar
2. Menu Bar
3. Icons
4. Form Title Bar
5. Tabs
6. Form Area
7. Status Bar
8. Required Field
 - a. Required fields are indicated by the bolding of the field name throughout AQS.

Note] the user should be able to see the entire screen with the exception of some of the longer records that require scrolling to view. If some of the screen seems to be missing (and there's no scroll bar), the user should verify the

resolution; 1280x1024 is the recommended minimum resolution.

Icons

Here is a listing of all Icons and their associated function.

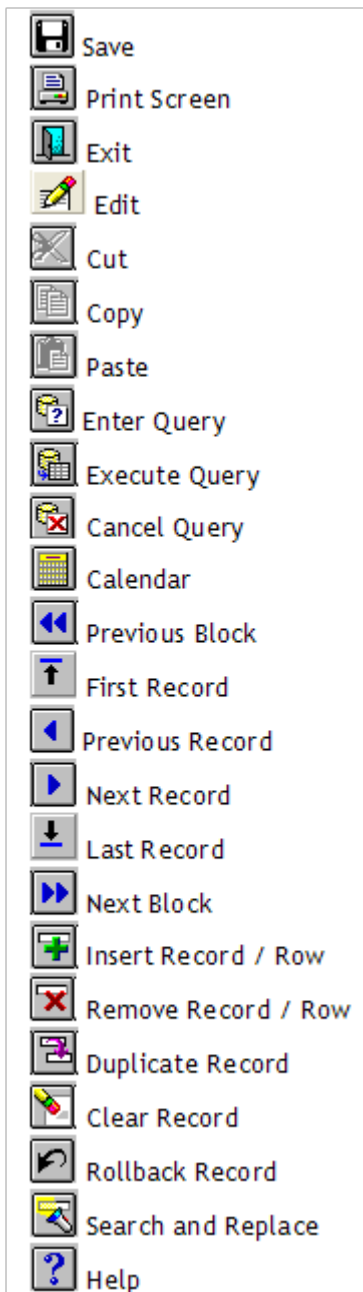

Note] hovering the mouse pointer over an icon will display its name.

Menu Bar, Form Area, and Tabs

Every menu item in the Menu Bar corresponds to a form within the Form Area. There may be multiple Tabs within a form. Tabs are used to display additional information related to the selected menu item.

The screen capture below shows that the Admin menu item was selected from the Menu Bar and the Security menu items was selected from the drop down menu opening up the Security form in the Form Area and the User Profile tab is highlighted allowing the user to interface with the User Profile portion of the Security form.

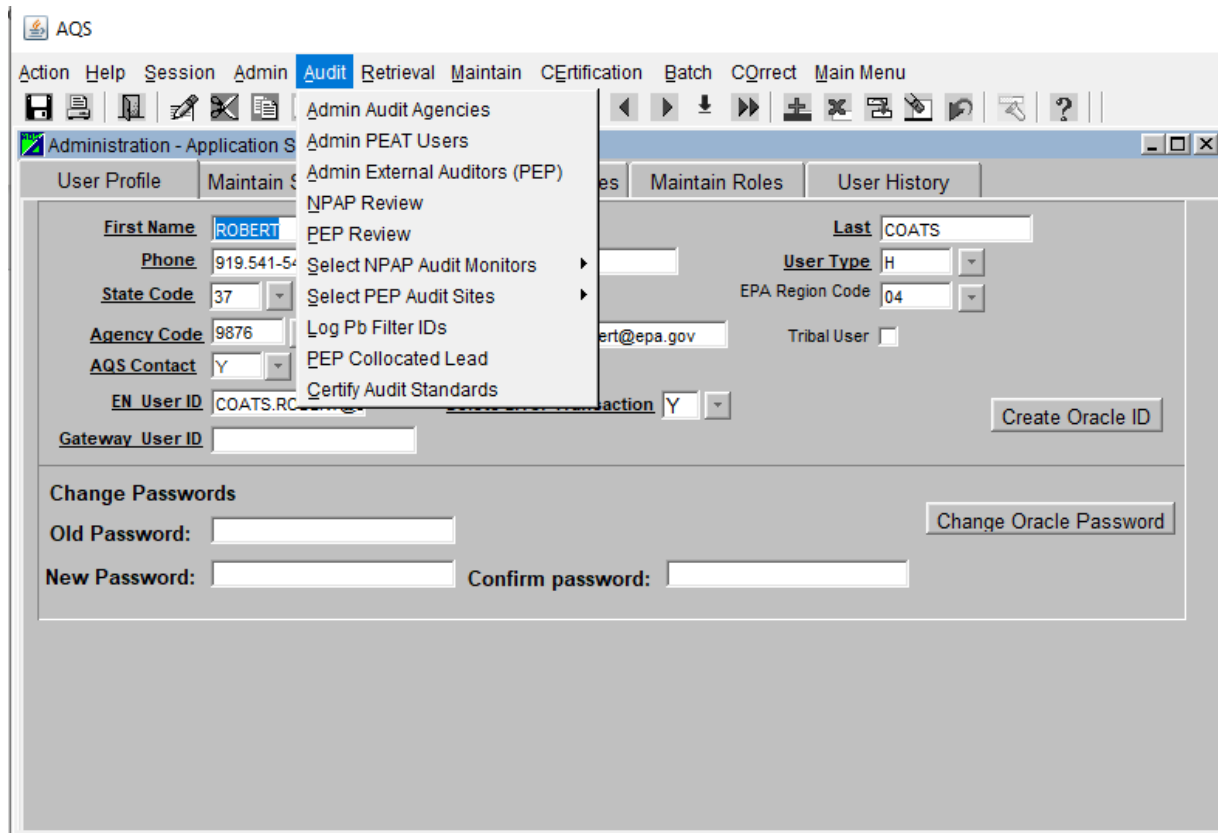

Note] Tabs will be located at either the top or right side of the Form Area.

Status Bar

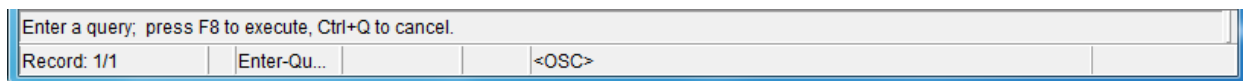

The first line of the status bar is a message area, and the second line shows the AQS query status. On forms that allow data to be entered or queried, the status bar shows the query status of AQS.

List of Values (LOV)

Whenever the user is required to populate data in AQS and the field contents must be one of a specific list of values, AQS presents an LOV (List of Values) icon. The LOV icon is a grey square with a downward pointing triangle in it.

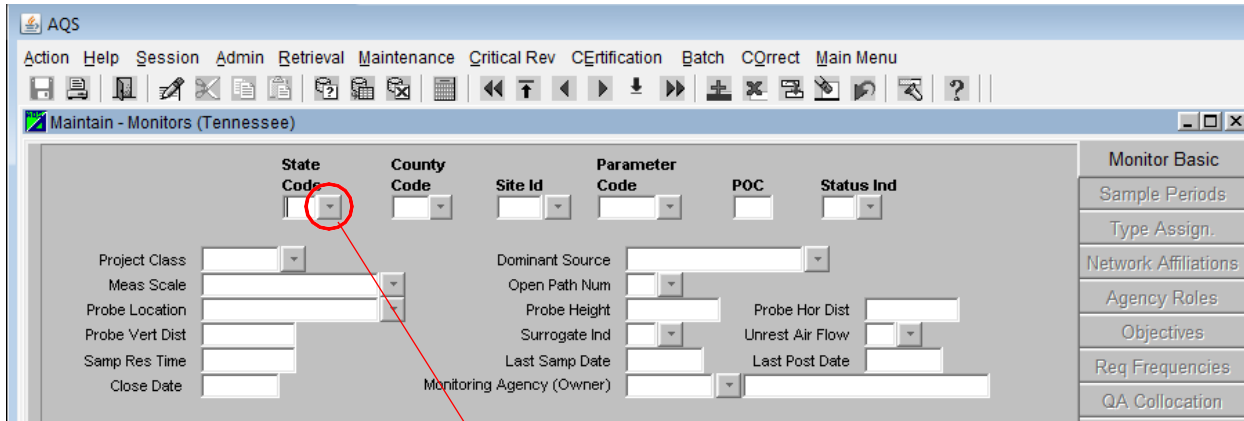

LOV (List of Values) Icon

When the LOV icon is clicked the list of valid values is presented. State Code LOV Icon was selected opening up the Valid Values pop-up window.

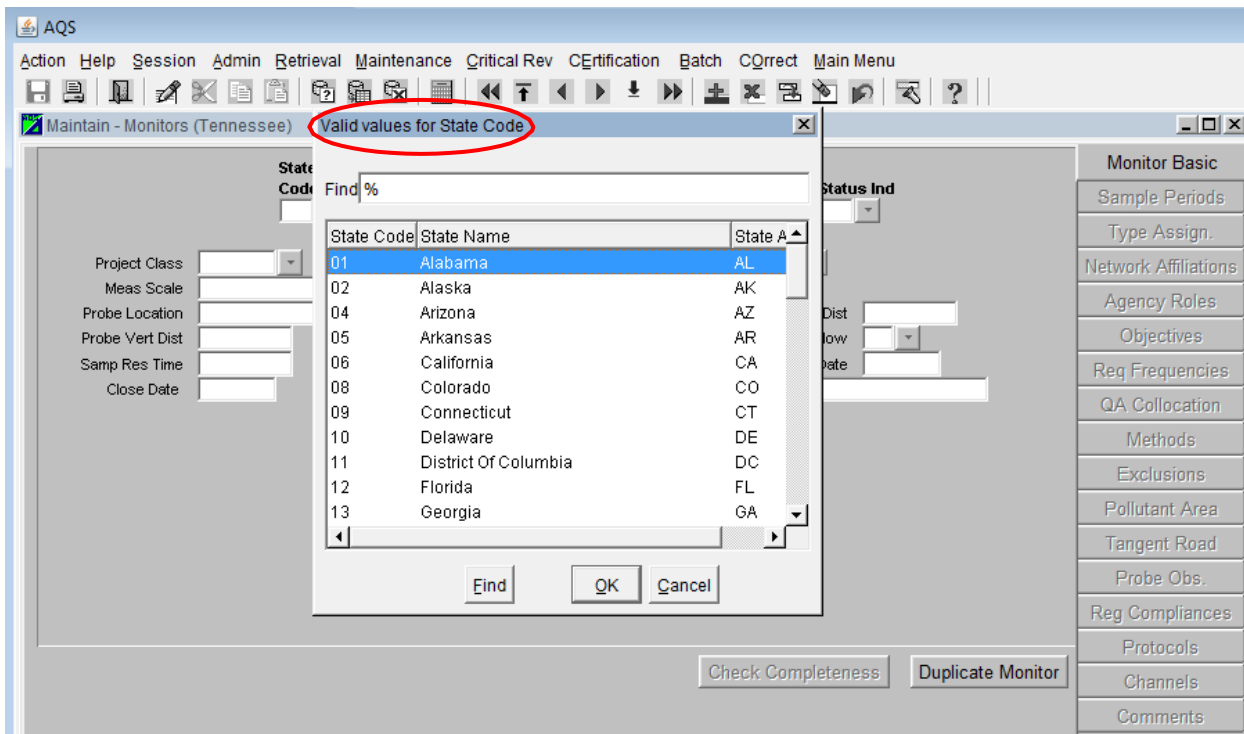

The Valid Values pop-up window allows the user to manually scroll (1) through the list or use the Find function (2) to narrow down the selection.

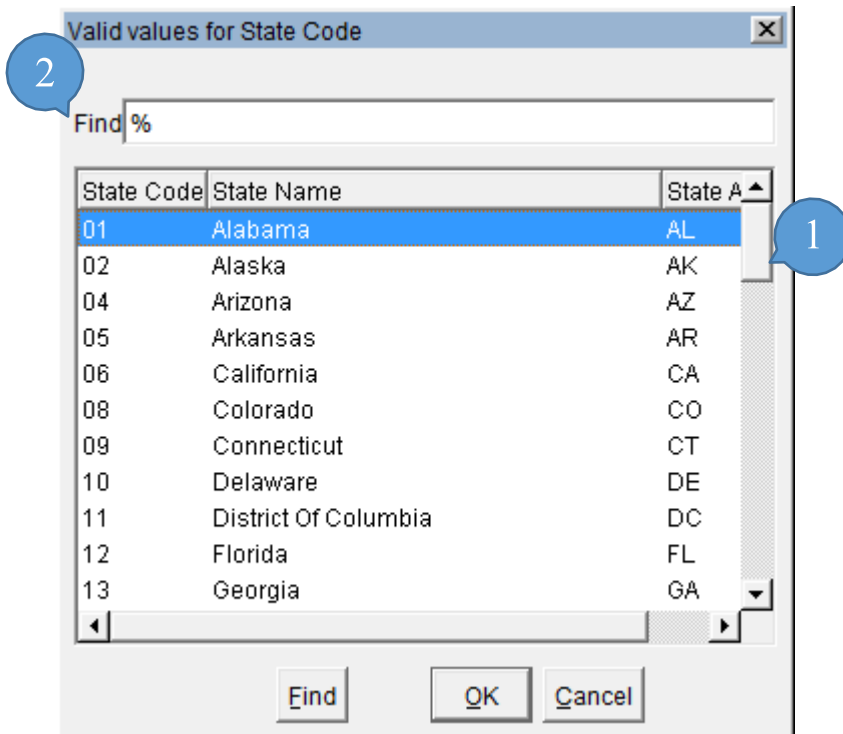

The Find function in AQS comes with Wildcard capability. When a Valid Values pop-up window opens, the Find field will be auto populated with the Wildcard Character. In AQS this is represented by a “%” (percent sign). The Wildcard Character is used to represent one or more characters when searching Valid Values.

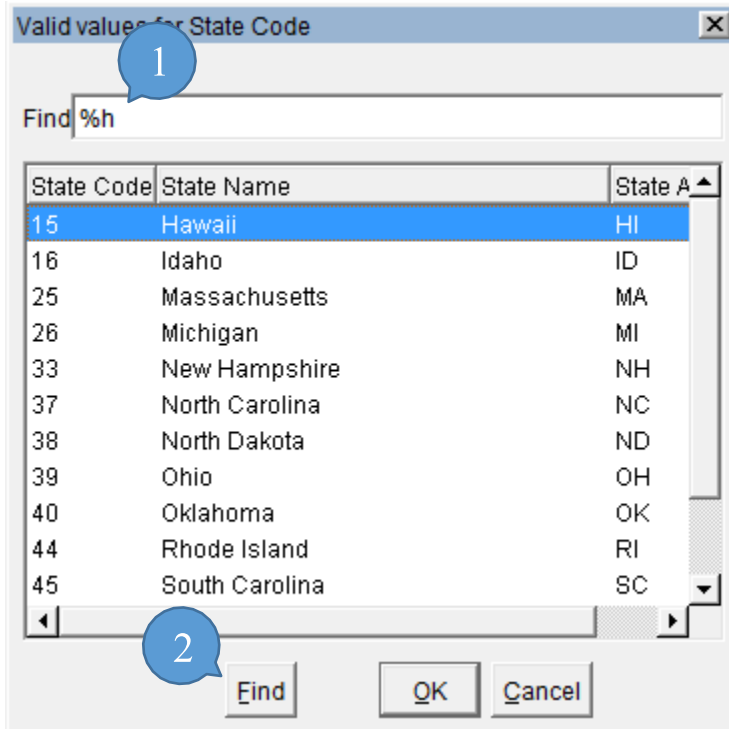

In the example above "h" was typed into the Find field next to "%" (Wildcard Character) (1). Then the Find button was clicked (2). This brought up only those states that contain an "h" in their name.

Note] the search function executes best with the wildcard, there is no need to remove it from the Find field.

Exchange Network Service Center (ENSC) at a Glance

All files must be submitted to AQS through the National Environmental Information Exchange Network (the “Exchange Network”). Typically, they are submitted through a common interface, the Exchange Network Service Center (ENSC).

Note] the ENSC is provided by the Exchange Network Governing Board to allow files to be submitted to EPA national regulatory programs. Because it is not part of AQS it has a different look and feel that is described below.

Screen Layout

The first step in any interactive batch data submission to AQS takes place at the ENSC.

The screenshot shows the ENSC interface with four numbered callouts:

- 1**: Points to the top header area containing the 'Environmental Information' logo, 'exchange Network' logo, and 'SERVICES CENTER' title.
- 2**: Points to the user login information in the top right corner, which includes 'Logged in: brooks.michaels@epa.gov' and links for 'My Profile', 'Help', 'Contact Us', and 'Logout'.
- 3**: Points to the navigation tabs: 'Home', 'My Services Center', 'Exchange Network Services', and 'News & Data Channels'.
- 4**: Points to the main content area, which is enclosed in a red dashed box. This area contains three large blue buttons: 'MY SERVICES CENTER' (with a person icon), 'EXCHANGE NETWORK SERVICES' (with a circular arrows icon), and 'NEWS & DATA CHANNELS' (with a RSS icon). To the right of these buttons is a 'My Quick Links' section with a 'Manage' link and a list of links: 'Exchange Network', 'Check your Submission (QA Services)', 'Exchange Network Discovery Services (ENDS)', and 'Production CDX Web'. Below the quick links is a green notification box with an exclamation mark icon and the text: 'Check out our News Feed for the latest on what's happening with the Exchange Network Services Center'.

At the bottom of the page, there are links for 'EPA Home', 'Privacy and Security Notice', and 'Contact Us'.

1. ENSC Title Bar
2. Quick Access Links
3. Tabs
4. Interactive Window

Note] details about how to use the ENSC are in the “Batch” section.

Logging On

The AQS application can be accessed through the application website <https://epa.gov/aqs>

Note] the user may be prompted with warning messages when attempting to run AQS.

- If prompted to trust or install a certificate the user should click YES.
- If prompted to block potentially unsafe components the user should click NO.

Logon Screen

AQS LOGON FORM

Database:

The Air Quality System (AQS) is a United States Environmental Protection Agency (EPA) computer system which may be accessed and used for authorized purposes only. Unauthorized access or use of this computer system may subject violators to criminal, civil, and/or administrative action. All information on this computer system may be monitored, recorded, read, copied, and disclosed to and by authorized personnel for official purposes, including law enforcement. Access or use of this computer system by any person, whether authorized or unauthorized, constitutes consent to these terms. AQS is exclusively for the use of federal, State, Territorial, and Tribal environmental agency employees and their delegates working in their official capacities.

Note] the first time AQS runs, the application may take several minutes to load.

The Database Field (1) is auto populated with the database that the user will connect to; normally this will not change. Once the Enter key is pressed or the Connect Button (2) is clicked, a browser window will open directing the user to login.gov to sign in. Once signed in go back to the AQS application and click the OK button.



For more information on registering at Login.gov visit [[LINK TO LOGIN.GOV DIRECTIONS](#)].

[Logging into AQS - Training Video](#)

[Interactive Training – How to Login to AQS](#)

Session Screen

After successful logon the user will be taken to the Session Screen where the user will have the option to continue as Read Only User or Screening Group Access. A screening Group roughly corresponds to an agency or similar organization. Users may be assigned to more than one screening group.

Read Only User:

- This allows access to all of the data in production status in the AQS database. It does NOT allow the user to view any data that is still being processed (i.e., “pre-production” data) or update any data.

Screening Group Access:

- Allows users of the selected screening group to view both production and pre-production data for monitors owned by that screening group. Each monitor and all data for that monitor is owned by only one screening group. Only users with update authority may insert, update, or delete data for the screening group. While using this mode, the user cannot view data owned by other screening groups.

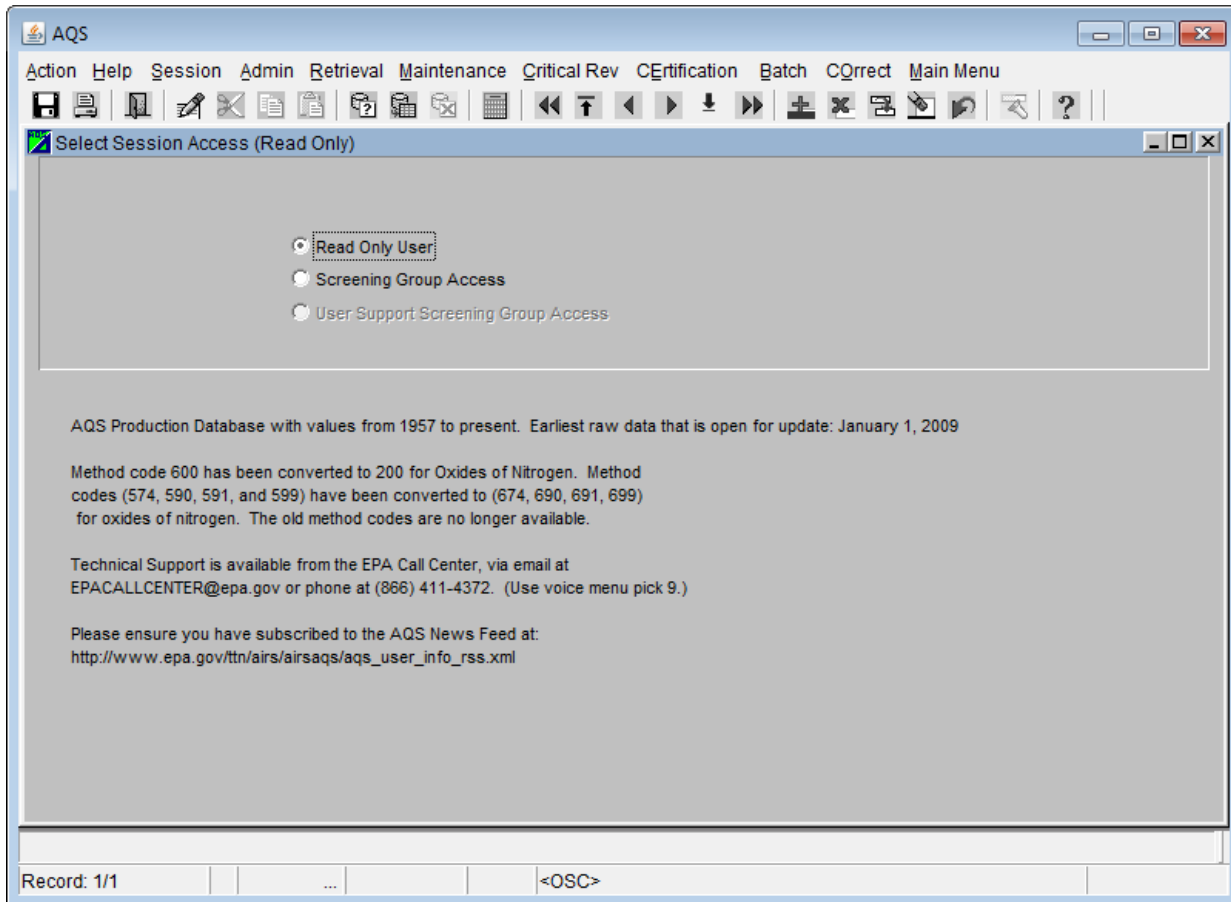

User Profile

All AQS users have a user profile that was created by an AQS administrator. The user should periodically review this information to ensure it is up to date.

From the Menu Bar the user should click Admin. This will open a Dropdown Menu, at this point the user should click Security. This will open the User Profile Form in the Form Area. The user should verify that their user information is correct.

Note] required fields are indicated by the bolding of the field name throughout AQS.

The screenshot shows the 'User Profile' form in the AQS Administration interface. The form is titled 'Administration - Application Security (Read Only)' and has several tabs: 'User Profile', 'Maintain Security', 'Security Reference Tables', 'Maintain Roles', and 'User History'. The 'User Profile' tab is active, displaying the following fields and values:

- First Name: ROBERT
- Initial: M
- Last: COATS
- Phone: Phone Number
- AQS User ID: RCG
- User Type: H
- State Code: 37
- Status Ind: P
- EPA Region Code: 04
- Agency Code: 9876
- E Mail: coats.robert@epa.gov
- Tribal User:
- AQS Contact: Y
- EN User ID: COATS.ROBERT@E
- Delete Error Transaction: Y
- Gateway User ID: Xrcoats

Below the main form is a 'Change Passwords' section with the following fields and a button:

- Old Password:
- New Password:
- Confirm password:
- Change Oracle Password button

At the bottom of the window, there is a search bar with the text 'Enter the user's First Name.' and a table showing 'Record: 1/1'.

Note] The new field, “Gateway _User_ID” is the common EPA user ID for the user. For new AQS users, it will exactly match their AQS_User_ID, while for users created before AQS adopted the EPA Gateway, it is mapped by the user profile into their AQS_User_ID.

Password

At the bottom section of the User Profile Form there is a change password area. To change the password the user will type the new desired password into the New Password field and then retype it in the Confirm password field. Clicking the OK button will implement the change.

The screenshot shows a dialog box titled 'Change Your Oracle Passwords'. It contains the following elements:

- AQS
- New Password:
- Confirm password:
- OK button

EPA IT Password Security Policies

Specific rules in this policy require the following:

1. Passwords shall be at least twelve (12) non-blank characters long.
2. All passwords, including initial passwords, shall be composed of a minimum of one character from at least three (3) of the following four (4) categories:

- a. English uppercase letters (e.g. A-Z);
 - b. English lowercase letters (e.g. a-z);
 - c. Non-alphanumeric special characters (e.g. !, @, #, \$, %, etc); and
 - d. Base 10 digits/numerals (e.g. 0-9).
3. Passwords shall not contain any of the following:
- a. Dictionary words (e.g. computer, work) or common names (e.g. Betty, Fred, Rover);
 - b. Portions of associated account names (e.g. user ID, login name);
 - c. Consecutive character strings (e.g. abcdef, 12345);
 - d. Simple keyboard patterns (e.g. QWERTY, asdfgh); and
 - e. Generic passwords (i.e. passwords consisting of a variation of the word "password" [e.g. P@sswOrd1]).
4. At least 50% of the characters shall be changed when new passwords are created.
5. Passwords may not be reused for 24 generations.

Note] For security reasons passwords must be changed at least every 60 days. It is important that AQS users maintain their passwords in an active status. Inactive passwords will be locked if they are not used within 30 days.

Tribal User

If the user prefers to have the geographic portion of the site ID in AQS presented in terms of Tribal ID rather than Federal Information Processing Standard (FIPS) State - FIPS County ID, the user can set that preference in the User Profile Form.

The screenshot shows the 'User Profile' tab of a web application. The form contains the following fields and values:

- First Name:** ROBERT
- Last:** COATS
- Initial:** M
- Phone:** Phone Number
- State Code:** 37
- Agency Code:** 9876
- AQS User ID:** RCG
- Status Ind:** P
- User Type:** H
- EPA Region Code:** 04
- E Mail:** coats.robert@epa.gov
- Tribal User:**
- EN User ID:** COATS.ROBERT@E
- Delete Error Transaction:** Y
- Gateway User ID:** Xrcoats

Select the checkbox labeled Tribal User.

After making the Tribal User selection the user must click the Save button or press F10 on their keyboard to save the selection.

Tribal users are not required to do this, however any user may opt to be a tribal user. This option can be deselected at any time.

Being a Tribal user will change the format of Site IDs on all AQS forms and reports. Instead of the default geographic format of:

State FIPS Code - County FIPS Code - Site Number

Sites will be displayed in the following format:

TT - Tribal Code - Site Number

The "TT" is an indicator that the next field is a tribal code and not a county code. The Tribal Code is the Bureau of Indian Affairs (BIA) Tribal code. AQS is not allowed to establish non-BIA codes for tribes.

Maintain Security

This is found under the Admin section on the Menu Bar then select Security then the Maintain Security tab. This tab allows the Data Administrator and Application Administrator to select, insert, update, and delete user assignments to Screening Groups and application roles.

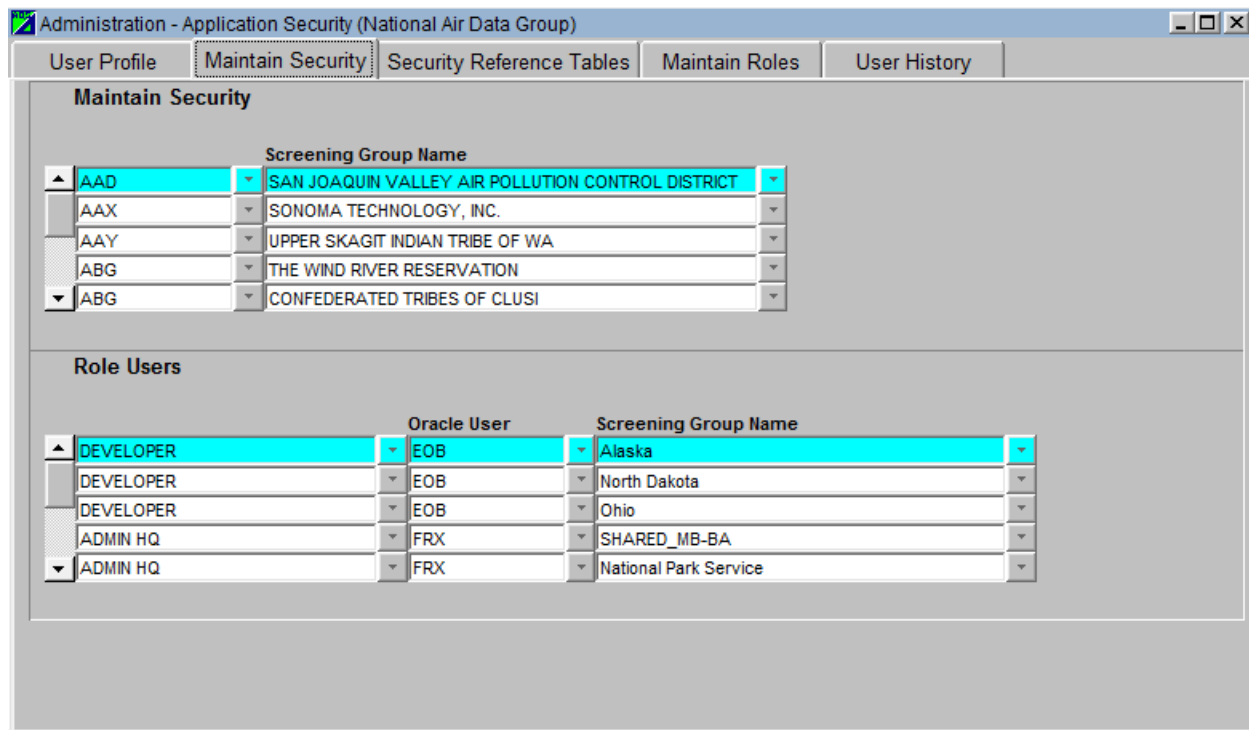

Maintain Security Reference Tables

This is found under the Admin section on the Menu Bar then select Security then the Security Reference Tables tab. This tab allows Data Administrators to maintain the security reference tables. Here the Data Administrator can create, update and delete new user types, Screening Group types, and Screening Groups.

Site ID Format

State Code

A two-digit FIPS code that identifies one of the 50 US states. May also indicate a Tribal Area (TT) or other country such as Canada (CC) or Mexico (80).

County Code

A three-digit FIPS code that identifies a county or the equivalent geo-political entity, such as a parish or independent city.

Tribal Code

Only visible in Tribal Mode. A two-digit FIPS code that identifies one of the federally recognized Native American tribal agencies when the Tribal Ind is set to "TT". If your Screening Group also has non-tribal data, this column will contain the County Code.

Site Number

A four-digit number used to uniquely identify a site within a county. Defined and maintained by the states or Tribal agencies. When this is a Tribal site care must be taken to ensure that the site ID is unique not only in the Tribal Area but also in all the counties that the tribal area includes or crosses.

Batch Submission of Data

[Understanding of Batch Submission of Data – Training Video](#)

Batch Data Submission Overview

Batch submission is loading a batch of data records all at the same time.

The advantages of batch loading data are:

- It allows for mass entry of data
- Processing of valid data happens without human interaction
- The system will notify the user when the process is complete
- Provides the user with results detailing the outcome

There are several steps used to submit data from a text file into the AQS database, those steps depend on the type of data involved. The big picture process involves:

- Transfer - move a data file to the EPA using the Exchange Network (node or ENSC)
- Load - Run a batch process to Load this data into the AQS database
- Post - For raw data only, after reviewing the results of load, flag data as production-ready (available to all)

- The process described here is for completing a batch submission using AQS interactively. An alternative is to use an organization’s node on the Exchange Network. For instructions on how to do that, see the AQS Flow Configuration Document on the Exchange Network website.

Formats

There are two data formats that may be submitted:

- AQS transactions - the AQS pipe delimited transaction format introduced in 2001
- XML - structured text data with <tags>

The format used will depend on what data acquisition system and/or analytical labs is available to the user. The vast majority of users take advantage of the AQS transaction format.

Data Compatible with Batch

Not all data in AQS can be loaded via the batch process. Here is a list of the types of data that can be loaded via batch:

- Site data
- Monitor data
- Raw (sample) data
- Quality Assurance data

Here are the types of data that cannot be loaded via batch:

- Comments (describing sites, monitors, audits, events, etc.)
- Exceptional event definitions, data associations, and concurrence (for EPA staff only)

Batch Data Submissions Flowchart

The following explains the data flow to AQS.

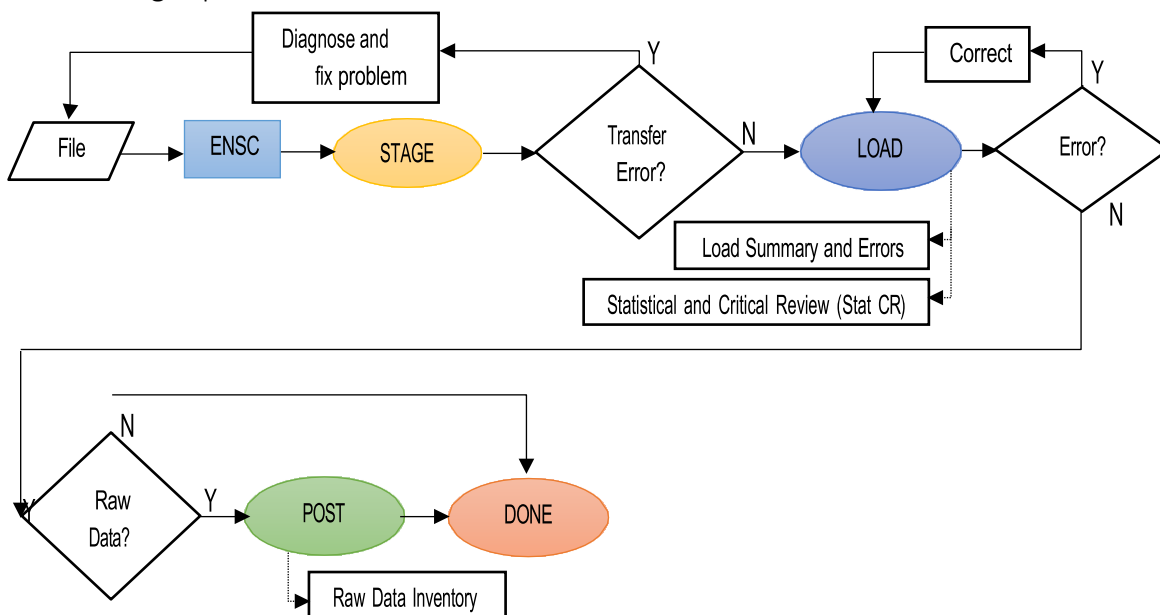

Step 1 (File):

Create file of ambient air data. Valid options are either text files (.txt) using the familiar delimited “Data Input Formats” or XML files (.xml) using the AQS Schema.

Note] Data Input formats can be found in here:

<https://aqs.epa.gov/aqsweb/documents/TransactionFormats.html>

Step 2 (ENSC):

Transfer the file to AQS using the Exchange Network Services Center (ENSC).

There are two process control options from the ENSC:

Option 1 – Manually process: logon to AQS, choose the Screening Group, and proceed to the Batch screen.

Option 2 – Automatically process: use the ENSC exclusively, bypass AQS and process all data via the ENSC.

Step 3 (STAGE):

Processes the file into AQS.

Step 4 (LOAD):

For anything other than Raw Data (i.e. sample measurements) if there were no errors in the file the processing is complete. For Raw Data, the LOAD step also performs STAT/CR (Statistical and Critical Review).

Step 5 (POST):

Moves data from where it can only be seen by members of the relative screening group to where it can be seen by any AQS user (and any EPA web application, and thus the public). It also updates all of the summary values (e.g., NAAQS durations, Daily, Annual, and Design Value if applicable) that the raw data contributes to. This also means that it will be used by EPA in any calculations (completeness, compliance, etc.).

Using the ENSC

The ENSC is at <https://enservices.epa.gov/login.aspx>. There is also a button on the AQS Batch Form Area that will open this web page.

10416	20141125 12:25	CRST-COMPLETED	10416	0	9	10416	0	
20	20141120 15:05	CRST-COMPLETED	20	0	1	20	0	
45	20141117 15:43	LOAD-COMPLETED	21	0				

Post

[Post File](#)

[Stat CR Report](#)

[Raw Data Inventory](#)

Other

[Show User Log](#)

[Goto ENSC](#)

[Refresh Sessions](#)

A file can be submitted through an organization’s node to AQS via the Exchange Network with processing instructions (The user’s IT department will have to set this up) or a file can be submitted manually.

For manually submitting a file the following instructions are provided.

The user will login to ENSC with the production Exchange Network account and password.

Environmental Information



SERVICES CENTER



[Help](#) | [Contact Us](#)

SERVICES CENTER

The Exchange Network Services Center is a web-based tool designed to allow Exchange Network users to easily send, get, and download information from other partners on the network.

Note: to access this tool, you must already have an Exchange Network user account assigned to you.

[Request an Account](#)

Warning Notice

This application is part of a United States Environmental Protection Agency (EPA) computer system, which is for authorized use only. Unauthorized access or use of this computer system may subject violators to criminal, civil, and/or administrative action. All information on this computer system may be monitored, recorded, read, copied, and disclosed by and to authorized personnel for official purposes, including law enforcement. Access or use of this computer system by any person, whether authorized or unauthorized, constitutes consent to these terms.

Login

Username:

Password:

Domain:
 [Not sure?](#)

[Forgot Username or Password](#)

[EPA Home](#) | [Privacy and Security Notice](#) | [Contact Us](#)

20

[Logging into ENSC – Training Video](#)

[Using the ENSC to Submit Files to AQS – Training Video](#)

[Interactive Training – Batch Loading Through the ENSC](#)

The first time a user logs into the ENSC they will need to add the AQS connection service to their list of services. In order to add the AQS connection the user will select the Exchange Network Services tab or click the 'Go' button on the Interactive Window area labeled EXCHANGE NETWORK SERVICES.

The screenshot shows the top navigation bar with the following elements:

- Logo: Environmental Information **Exchange Network**
- Page Title: **SERVICES CENTER**
- User Info: Logged In: brooks.michaels@epa.gov
[My Profile](#) | [Help](#) | [Contact Us](#) | [Logout](#)
- Navigation Tabs: Home, My Services Center, **Exchange Network Services** (highlighted with a red box), News & Data Channels

The main content area features three large blue buttons:

- MY SERVICES CENTER**: Quickly access the services and queries you use and check the status of your requests **GO**
- EXCHANGE NETWORK SERVICES**: Send, get, and download information from Exchange Network partners **GO** (highlighted with a red box)
- NEWS & DATA CHANNELS**: View news and data feeds from Exchange Network partners, subscribe to channels of interest, or contribute your own content to these channels **GO**

On the right side, there is a "My Quick Links" section with a "Manage" link and a list of links:

- » Exchange Network
- » Check your Submission (QA Services)
- » Exchange Network Discovery Services (ENDS)
- » Production CDX Web

Below the quick links is a green box with an exclamation mark icon and the text: "Check out our News Feed for the latest on what's happening with the Exchange Network Services Center".

This is a close-up of the "EXCHANGE NETWORK SERVICES" button. It contains the text: "Send, get, and download information from Exchange Network partners **GO**". The "GO" button is highlighted with a red box. To the right of the text is a circular arrow icon.

At this point the user will type AQS into the search field of the Express Request box.

The screenshot shows the top navigation bar with 'Home', 'My Services Center', 'Exchange Network Services', and 'News & Data Channels'. Below the navigation bar is a message: 'Use either the Step-by-Step OR Express approach to send, get, or download information from the Exchange Network.' Below this message are two panels. The left panel is titled 'Guide Me Step-by-Step (recommended for novice users)' and contains 'Step 1: Choose the Type of Transaction to Perform' with three radio button options: 'Send information to a system on the Exchange Network', 'Get information that is stored on the Exchange Network', and 'Download a document from the Exchange Network'. The right panel is titled 'Express Request (recommended for advanced users)' and contains a search box with 'AQS' entered, a 'Search' button, and a 'Browse Services Directory' button. A large 'OR' is placed between the two panels.

The Service Directory window will open displaying a list of choices. The user will click the Send Info link for the AQS Submit service.

The screenshot shows the 'Services Directory' window. At the top, it says 'This directory runs from Exchange Network Discovery Service (ENDS) metadata. It requires the commitment of our Network to keep it up to date and useful. For the BETA version, the Services Directory contains only services that support Submit, Query, Solicit, and Download operations. Select the name of the Service you wish to use.' Below this is a search filter section with 'Filter By: Keyword(s)' and a search box containing 'AQS'. Below the search box is a table with 6 columns: 'Service Transaction', 'Dataflow', 'Service Name', 'Service Description', 'Node', and 'Service Provider'. The table contains 4 rows of data. The second row, 'ProcessAQSDoc', and the third row, 'AQS Submit', are highlighted. The 'AQS Submit' row is also enclosed in a red box. The 'Send Info' link for the 'AQS Submit' row is also highlighted with a red box.

Service Transaction	Dataflow	Service Name	Service Description	Node	Service Provider
Get Info	AQDE	AQDERawData	Queries or Solicits the Raw Data for the AQDE Flow. The return is an XML file that conforms to the AQS Version 2.0 Schema.	NewJerseyNodeV1_Prod	NJDEP
Send Info	AQS	ProcessAQSDoc	Air Quality System Document Submissions	.NetNode2	U.S. Environmental Protection Agency
Send Info	AQS	AQS Submit	AQS Submit: Send files to the Air Quality System (AQS).	NGNProd2.0	U.S. Environmental Protection Agency
Get Info	AQS	GetAQSRawDataInsertByDate	AQS - GetAQSRawDataInsertByDate Service	NV	Nevada Division of Environmental Protection (NDEP)

The user will then complete the Express Request form.

The screenshot shows a web form titled "Express Request: AQS Submit" with a green header. The form contains several fields and buttons, each with a blue circular callout number:

- 1**: A "Choose File" button next to the text "No file chosen".
- 2**: A text input field for "Enter Sender's Email Address to Notify of Transaction Status Changes:".
- 3**: A text input field for "AQS User ID:".
- 4**: A dropdown menu for "Screening Group :" with "50 Test User Screening Group" selected.
- 5**: A dropdown menu for "File Type :".
- 6**: A dropdown menu for "Final Processing Step :".
- 7**: A dropdown menu for "Stop On Error :".
- 8**: A blue link that says "Provide information (metadata) about this Document (recommended)".
- 9**: A green "SEND DATA" button.

At the bottom right, there is a "Cancel" link and the "SEND DATA" button.

1. The Choose File button allows the user to select a document from their local computer or network.
2. File transfer information will be sent to the email address the user inputs into this field. The user can input one or multiple email addresses (this field is optional). Multiple email addresses must be separated by commas.
3. The user must input the AQS User ID assigned.
4. The user will select, from a drop down menu, the screening group the user is submitting data for.
5. The user will select the appropriate file type (format) from the drop down menu.
 - a. AQS text transactions (MA, RD, etc.) are flat files.

6. The Final Processing step is where the user provides AQS with instructions on how far to process the file before stopping and waiting for the user to log on and review/complete processing.
 - a. Stage copies the data from the submitted file into the AQS database, but does no processing of the contents of the file. If an error is reported during the stage process, the problem must be fixed in the user's data file and resubmitted.
 - b. Load moves the submitted data into the AQS database and performs field validation (i.e. is each field on each transaction valid) and relational checks (i.e. is pre-requisite data present). If errors occur during the load process, the user can fix the error in AQS via the Correct Forms or the user can correct the problem in their own database and start the process over.
 - i. Some data can complete the load process while other data has errors.
 - ii. For Raw Data Only: AQS runs a variety of statistical tests on the data to look for statistical anomalies (outliers). The user will receive warnings (not errors) if the data is flagged by a statistical check.
 - c. For Raw Data Only: Post changes the status of the data from where it can only be seen by members of the user's screening group to where it can be seen by any AQS user. Also, all of the relevant summary values will be updated in this step.
 - i. The user cannot have an error during the Post process.
 - ii. To process the file as far as possible, select Post.
7. The user will select either 'Yes' or 'No' for the Stop on Error processing command.
 - a. Yes prompts AQS to examine the results of the stage and load programs (both for errors and warnings) and stop any additional processing of the file if there are any errors or warnings in the data.
 - b. No prompts AQS to process all the data it can through the final processing step you selected.
8. The user can optionally provide additional data by expanding the Provide information (metadata) about this Document, but it is not necessary. AQS will not store this additional metadata.
9. After the user has entered values for all of these fields the user should click the Send button to begin the AQS submit process.

After the user clicks the Send button the 'Request Received!' screen will appear.

Environmental Information
exchange Network | **SERVICES CENTER**

Home My Services Center Exchange Network Services News & Da

Request Received!

Your File AMP501_1280016-0.txt has been received.

The following Transaction ID has been assigned to this request:
_299dbc2f-62c4-4f8f-8c5d-115362017425

Current Status of Request:

Transaction Status	Service Name	Transaction Type	Date
Processing	AQS Submit	Send Information	3/2/2015 2:58 PM

What would you like to do next?

- [View the Status of this request in My Activity](#)
- [Complete another Transaction using this same Service](#)
- [Complete another Transaction using a different Service](#)
- [Add this Service to My Quick Links](#)
- [Log out of the Services Center](#)

The screen will display the status and a transaction ID. From here the user can select a link under the 'What would you like to do next?' header. An email, from cdx@epa.gov, containing the file transfer information will be sent to the email address or addresses the user input into the 'Enter Sender's Email Address to Notify of Transaction Status Changes:' field. AQS will also send the user (to the address AQS has on record) an email summarizing all processing with links to reports.

Job Status

The values for the Job Status reflect how the batch job ran. They are:

Ran	Job completed
Not Run Yet	Job has not run yet.
Failed Before Run	Some error occurred that caused the job not to run. User should contact support.
Failed During Run	Some error occurred during the execution of the module. User should contact support.

ENSC Subsequent Uses

After the initial submittal all subsequent submittals can be processed through the 'My Service Center' interactive window. After logging into ENSC the user will select the My Service Center tab or click the 'Go' button on the Interactive Window area labeled MY SERVICE CENTER.

The screenshot shows the Exchange Network Services Center interface. At the top left, it says "Environmental Information" and "exchange Network". The main header is "SERVICES CENTER". On the top right, it says "Logged In: brooks.michaels@epa.gov" with links for "My Profile", "Help", "Contact Us", and "Logout". Below the header is a navigation bar with four tabs: "Home", "My Services Center" (highlighted with a red box), "Exchange Network Services", and "News & Data Channels".

The main content area has three large blue tiles:

- MY SERVICES CENTER**: "Quickly access the services and queries you use and check the status of your requests" with a "GO" button.
- EXCHANGE NETWORK SERVICES**: "Send, get, and download information from Exchange Network partners" with a "GO" button.
- NEWS & DATA CHANNELS**: "View news and data feeds from Exchange Network partners, subscribe to channels of interest, or contribute your own content to these channels" with a "GO" button.

On the right side, there is a "My Quick Links" sidebar with a "Manage" link and four links: "Exchange Network", "Check your Submission (QA Services)", "Exchange Network Discovery Services (ENDS)", and "Production CDX Web". Below this is a "Check out our News Feed" notification with an exclamation mark icon.

This will open the My Service Center interactive window.

Environmental Information
exchange Network
SERVICES CENTER
 Logged In: brooks.michaels@epa.gov
[My Profile](#) | [Help](#) | [Contact Us](#) | [Logout](#)

Home My Services Exchange Network Services News & Data Channels My Quick Links ▼

My Services | [My EPA Activity](#) | [My Channels](#) ⊕ Add this page to My Quick Links

Make this my Start page

My Services ? Access services you have used before. [Use a New Service](#)

All Send Info Get Info Download My Queries

Find a Service: My Services Services Directory

Service Name	Service Description	Publisher	RSS-enabled	Last Used
NGNProd2.0/AQS/AQS Submit	AQS Submit: Send files to the Air Quality System (AQS).	U.S. Environmental Protection Agency	No	3/2/2015 2:58:04 PM

1. To send data to AQS the user will select the 'Service Name' ending in AQS Submit.
 - a. The user should verify that the 'Service Description' shows AQS Submit: Send files to the Air Quality System (AQS).
2. The user can see previous submissions by selecting the 'My EPA Activity' link.
3. The user has the option to make this page the Start page, reducing the necessary steps for submitting data.

Loading Files Using AQS

This section covers the file processing functions available within AQS. This section assumes that a file that has been through the stage process but has gone no further in AQS. (This would be the case if the Final Processing Step from the ENSC was Stage.)

[Loading Files Using AQS – Training Video](#)

Batch Form Overview

After logging in to AQS the user will select Batch from the Menu Bar.

The screenshot displays the AQS BATCH (Tennessee) interface. At the top, there is a menu bar with options: Action, Help, Session, Admin, Retrieval, Maintenance, Critical Rev, Certification, Batch, CQrect, and Main Menu. Below the menu bar is a toolbar with various icons. The main window title is "BATCH (Tennessee)" and it has tabs for "Process by File" and "History".

The central part of the interface is a table titled "HISTORY AND STATUS". The table is divided into three main sections: "HISTORY AND STATUS", "LOAD", and "POST". The "HISTORY AND STATUS" section contains a table with the following columns: Submission Date, File Name, User Name, Records In File, Date (last), Process Status, Recs Loaded, Recs Failing to Load, Stat/CR Finding Count, Records to Post, Skip'd Monitors, and Records Posted. The first row is highlighted in blue and shows a submission on 20141218 16:28 for file "EastmanNovember14.txt.zip" by user "BILLY PUGH" with 10806 records, processed on 20141218 16:39, with a status of "POST-COMPLETED", 10798 records loaded, 0 failing, 5 findings, 10792 records to post, 0 skip'd monitors, and 10792 records posted.

Below the table is a "PROCESS CONTROL" section with three main areas: "Load", "Post", and "Other". The "Load" area has buttons for "Load File" and "Load Summary and Errors". The "Post" area has buttons for "Post File" and "Raw Data Inventory". The "Other" area has buttons for "Show User Log", "Goto ENSC", and "Refresh Sessions".

At the bottom is a "PROCESS FLOW" diagram. It starts with a "FILE" circle leading to an "ENSC" rectangle, then to a "Stage" oval, then to a "Transfer Error?" diamond. If "Y" (Yes), it goes to "Diagnose and fix problem" and back to "FILE". If "N" (No), it goes to "Load" oval, then to an "Errors?" diamond. If "Y", it goes to "Correct" and back to "Load". If "N", it goes to "Raw Data?" diamond. If "Y", it goes to "Post" oval, then to "Raw Data Inventory" rectangle, then to "DONE" oval. If "N", it goes to "Statistical and Critical Review (Stat CR)" rectangle, then to "Raw Data Inventory" rectangle, then to "DONE" oval.

AQS Batch Form Overview – Training Video

Process by File Tab

The “Process by File” tab shows a summary of all of the processing that has been performed by AQS for a submitted file.

The AQS Batch “Process by File” tab has 5 main areas.

1. File processing History and Status area.

HISTORY AND STATUS					
Submission Date	File Name	User Name	Records In File	Date (last)	Process Status
20141218 16:28	EastmanNovember14.txt.zip	BILLY PUGH	10806	20141218 16:39	POST-COMPLETED
20141212 15:53	TN Oct Precision.txt.zip	BILLY PUGH	28	20141212 16:10	LOAD-COMPLETED
20141211 11:08	TNOct2014continuous.txt.zip	BILLY PUGH	14136	20141211 11:31	POST-COMPLETED
20141202 12:05	NYRStar Oct 2014.txt.zip	BILLY PUGH	2991	20141202 12:33	POST-COMPLETED
20141202 12:15	TN AQSReport Sep 2014.txt	BILLY PUGH	13680	20141202 12:33	POST-COMPLETED
20141202 11:58	PbTnq3.txt.zip	BILLY PUGH	32	20141202 11:59	POST-COMPLETED
20141125 14:42	TDEC_AQS PM2.5_Septem	EVELYN HASKIN	657	20141125 14:49	POST-COMPLETED
20141125 12:09	Eastman Oct 2014AQSRepo	BILLY PUGH	11166	20141125 12:27	POST-COMPLETED
20141125 12:24	ResoluteFP102014.txt.zip	BILLY PUGH	10416	20141125 12:25	CRST-COMPLETED
20141120 15:04	Exide October 2014 Data.txt	BILLY PUGH	20	20141120 15:05	CRST-COMPLETED
20140807 10:47	RAQ22014.txt.zip	BILLY PUGH	45	20141117 15:43	LOAD-COMPLETED

The History and Status area shows a list of the files that have been submitted and the most recent action performed. There is one row per file.

There are six columns in this area, and they are:

- Submission Date: This indicates the original date and time the file was staged to AQS (the format: YYYYMMDD HH:mm where HH is on the 24 hour clock and Eastern Time).
- File Name: The name of the file.
- User name: The name of the last user in the agency who initiated a processing step for this file.
- Records in file: The total number of transactions in the file (records if it is a flat file, the equivalent for XML).
- Date (last): The last time an action was performed on this file.
- Process Status: The most recent process initiated for this file and the status of that process.
 - Process can be:
 - Stage = Converting data from submitted format to AQS database format
 - Load = Loading data into AQS database
 - CRST = Critical Review and Statistical Tests
 - Post = Incorporate data into summaries and make data public.

- o Status can be:
 - Submitted (meaning it is waiting to execute)
 - Active (actively processing)
 - Error (completed with errors)
 - Completed (completed with no errors)

2. Load processing results summary.

LOAD		
Recs Loaded	Recs Failing to Load	Stat/CR Finding Count
10798	0	5
28	0	
14136	0	0
2991	0	0
12960	0	0
32	0	0
587	18	0
11166	0	6
10416	0	9
20	0	1
21	0	

The Load processing results summary. This area provides a summary of what happened to each record (transaction) in the file during all of the load processes.

There are three columns in this area, and they are:

- Recs Loaded: The total number of records from this file that have been successfully loaded into AQS. Keep in mind, Load means different things for different types of data. For everything but raw data, it means it is now fully into AQS. Raw data: the data still needs to be posted.
- Recs Failing to Load: The number of records that could not be loaded into AQS due to some kind of error. The "Recs Loaded" plus the value in this column should equal the number of records in the file.
- StatCR Finding Count: The number of records that raised concern during Statistical and Critical Review process (StatCR). The StatCR process is run automatically every time the load process is run with Raw Data. It compares new data to old data and expected ranges, etc. and presents any "findings" of possible outliers or other problematic data. These are not errors, they are oddities in the data flagged for user information.

3. Post processing results summary.

POST		
Records to Post	Skip'd Monitors	Records Posted
10792	0	10792
1	0	14136
2986	0	2986
12960	0	12960
30	0	30
571	0	571
126	0	11160
10416	0	
20	0	

The Post processing results summary area provides a summary of the file with respect to the POST processes.

There are three columns in this area, and they are:

- Records to Post: The total number of Raw Data records from this file that need to be posted (the number of successfully loaded raw data records). If this number is more than zero, the Post process needs to be executed to complete the submission of this data to AQS.
- Skip'd Monitors: The number of monitors for which the posting of data was skipped during processing. This should only happen if another user is editing or submitting data for the same monitors.
- Records Posted: The number of records for which post processing completed successfully. When this number matches the "Records to Post" column for the file, processing is complete.

4. Process control - where results can be reviewed, and additional processes performed on files.

PROCESS CONTROL	Load	Post	Other
Process selected file through:	<input type="button" value="Load File"/>	<input type="button" value="Post File"/>	<input type="button" value="Show User Log"/>
Results and Reports:	<input type="button" value="Load Summary and Errors"/> <input type="button" value="Stat CR Report"/>	<input type="button" value="Raw Data Inventory"/>	<input type="button" value="Goto ENSC"/> <input type="button" value="Refresh Sessions"/>

The Process control area allows the user to review results of earlier processed files and perform additional processing. **The process control area only acts on the file (row) that is highlighted on the top part of the form.**

Depending on the status of the file, certain areas will be unavailable (grayed out). The processing of files is controlled on the horizontal row labeled "Process selected file through"

The user can select either load or post. Selecting post will perform load processing on the file if necessary.

The available reports generated by each process are shown below the process. For example, the load process generates two reports, the Load Summary and Errors report and the Stat CR Report. The post process generates only one report, the Raw Data Inventory report.

PROCESS CONTROL	Load	Post	Other
Process selected file through:	<input type="button" value="Load File"/>	<input type="button" value="Post File"/>	<input type="button" value="Show User Log"/>
Results and Reports:	<input type="button" value="Load Summary and Errors"/> <input type="button" value="Stat CR Report"/>	<input type="button" value="Raw Data Inventory"/>	<input type="button" value="Goto ENSC"/> <input type="button" value="Refresh Sessions"/>

Note] Reports can only be retrieved within two weeks of the Submission Date.

The last group of buttons in the Process Control area are labeled 'Other', they perform the following actions:

- Show User Log: This opens the same file that was emailed to the user (summarizing the most recent processing on the file) in a browser window.
- Goto ENSC: This opens an ENSC (file submission) window in a browser window.
- Refresh Sessions: This updates all of the information on the top part of the screen. If the user is waiting for a job to finish, the user can press this button rather than reloading the entire form to get updated information.

5. Process flow - A reminder of how AQS processes a file.

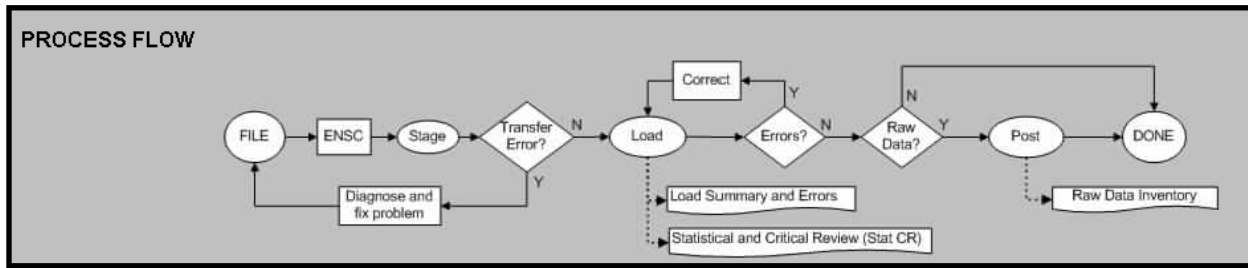

Stage

The first step is to Stage the data file. This means to transfer the file to AQS via the Exchange Network and then to convert the data to the AQS database format.

The following are the most common errors that can occur with Stage:

1. If the file never shows up on the Batch form, then there was a transfer error and AQS never received the file.
 - a. To diagnose: Review the status email from the Exchange Network and contact the Exchange Network Node Help Desk. (Email: nodehelpdesk@epacdx.net, Phone: (888) 890-1995).
2. All Stage failures where AQS actually receives the file result in the status, "UPLOAD- FATAL" on the batch form. The email from the Exchange Network will provide a status that can be interpreted as follows:
 - a. "E_AccessDenied: Access Denied" This means that the AQS user-id provided on the ENSC submission form is not authorized for the Exchange Network user-id that submitted the file. The user can configure this on the AQS Admin/Security form.
 - b. "E_LoaderNoProcess: AQSLOAD process is not active." This means that the AQS batch process started, but did not finish. Contact the EPA Call Center (Email: epacallcenter@epa.gov, Phone: (866) 411-4372) for assistance.
 - c. "E_LoaderStartLimitExceeded: AQSLOAD start time limit has been exceeded." This means that the user's account is not set up properly for batch submissions. Contact the EPA Call Center for assistance.
 - d. "E_AccessDenied: Unknown AQS User Id specified. Access Denied." This means that an invalid AQS user-id was provided on the ENSC submit form.
 - e. "E_InvalidScreeningGroup: Invalid Screening Group" This means that the user is not authorized for the selected screening group. The user should check the screening group provided and correct if incorrect, or contact the EPA Call center if the user needs access to that screening group.

Load

After the file has been staged, it can be loaded. Loading the file moves the submitted data into the main AQS database and performs field validation and relational (e.g., is pre-requisite data present) checks.

PROCESS CONTROL	Load
Process selected file through:	<input type="button" value="Load File"/>

The Statistical Tests and Critical Review (sometimes abbreviated StatCR or CRST) process is also performed at the end of the load step for Raw Data.

This process compares data to other values and expected ranges, etc. and presents any "findings" of possible outliers or other problems. These "findings" are not errors, they are really indications of a data point that is an outlier. The data may be fine, but the user should be alerted to any potential problems.

LOAD		
Recs	Stat/CR	
Recs	Failing	Finding
Loaded	to Load	Count
10798	0	5

Note] the results of the StatCR process can change over time. For example, the data representing an incomplete calendar quarter may be different from a complete calendar quarter (this includes data in the submitted file plus any data already in AQS).

The Load process generates the "Load Summary and Errors" report and the "Statistical and Critical Review" report.

Also, the fields in the Load Status area at the top of the form will be updated and the system will send the user an email with a summary of processing and links to all reports that were generated. This includes a link to a file that only contains the records in error.

Results and Reports:	<input type="button" value="Load Summary and Errors"/>	<input type="button" value="Stat CR Report"/>
----------------------	--	---

Load Summary and Errors Report

This report contains two parts. Load Summary and Load Detail.

The first is a table summarizing, by transaction type, the number of records in error and the number of records loaded (in the column labeled "Pre-Production") and the number of records posted. Recall, raw data records will be loaded (to pre-production) and any records that are not raw data will be posted if they are not in error.

The second part of this report details any errors in the data on a record by record basis. The data, in transaction format, will be presented along with the error related to that record. If there are more than a few thousand errors in the file, the system stops listing them so the report will not include all of them.

Statistical and Critical Review report

The second report generated by the load process contains information about irregularities in the processed data. These are not errors, but warnings (or "findings"). This report will list the monitor, the date/time, and the problem with any data values.

Load Errors

The "Records Failing to Load" column at the top of the screen or the Load Summary and Errors report will show the user if there are load errors.



Clicking the Load Summary and Errors button will open the LOAD Report in a separate browser window. The third page of this report is where the Load Detail can be found.

EPA United States Environmental Protection Agency Air Quality Subsystem Load Report

Jul. 23, 2013

Load Detail

File Name : *_id_test_pm-1.txt.zip*
 Screening Group : Idaho

Site/Monitor ID: 16-041-0001-88101-4 Table Name: ST_RAW_DATA		1
Transaction RD II 16 041 0001 88101 4 1 105 181 20130401 00:00 5200.0	Column Error Description Error Code	
Relational	Standard value falls outside absolute value range for the parameter.	-20723
Site/Monitor ID: 16-041-0009-88101-4 Table Name: ST_RAW_DATA		2
Transaction RD II 16 041 0009 88101 4 1 105 181 20130401 01:00 2.1	Column Error Description Error Code	
Multiple Columns	Monitor ID (State, County, Site, Parameter, POC) not in database	-20405
Site/Monitor ID: 16-041-0009-88101-4 Table Name: ST_RAW_DATA		
Transaction RD II 16 041 0009 88101 4 1 105 181 20130401 02:00 4.5	Column Error Description Error Code	
Multiple Columns	Monitor ID (State, County, Site, Parameter, POC) not in database	-20405
Site/Monitor ID: 16-041-0009-88101-4 Table Name: ST_RAW_DATA		
Transaction RD II 16 041 0009 88101 4 1 105 181 20130401 03:00 -0.9	Column Error Description Error Code	
Multiple Columns	Monitor ID (State, County, Site, Parameter, POC) not in database	-20405

1. The raw data value is outside the acceptable values (the wrong unit code in the file).
2. An incorrect site ID on the raw data transaction.

If errors occurred during the load process, there are two ways that the data can be fixed. The first is to fix it in AQS via the Correct option in the Menu Bar. (How to use Correct to edit the data is covered elsewhere.) The second option is to use the link to the file of error transactions from the batch job email, to download the file, fix the errors, and resubmit.

Raw Data

If the user's file contains raw data the user must complete the Post process. If the file contains no raw data the data has been placed in the public part of the AQS database and the file process is complete.

Post

The post process is necessary for raw data. It moves data from where it can only be seen by members of a select screening group to where it can be seen by any AQS user (and any EPA web application, and thus the public). It also updates all of the summary values (e.g., NAAQS durations, Daily, Annual, and Design Value if applicable) that the raw data contributes to.

It is built into the process as a stopping point to allow for review of any load errors or statistical findings before making the data public.

Note] when the user Posts a file, it is run through both the Load (including the StatCR) and Post processes in AQS. This is to ensure that all the data in a file is processed together and no "stragglers" are left behind in our multi-step process. The unfortunate side effect of this is that older Load Summary and Error and Stat CR reports will be overwritten with new (and perhaps empty) results. If a prior version of these reports is needed, it can be obtained using the history tab. (All reports are deleted from AQS after two weeks.)

Raw Data Inventory report

The Post process generates the Raw Data Inventory report. This report is a count by monitor and calendar quarter of the types of data actions (insert, update, and delete) that were taken by AQS.

PROCESS CONTROL	Load	Post
Process selected file through:	<input type="button" value="Load File"/>	<input type="button" value="Post File"/>
Results and Reports:	<input type="button" value="Load Summary and Errors"/>	<input type="button" value="Stat CR Report"/>
		<input type="button" value="Raw Data Inventory"/>

After running the Post process the submittal of raw data is complete.

When Things Go Wrong

Unfortunately, not all files will be submitted in one step from the ENSC. Files may have an error that causes batch processing to stop (whether the entire file stops processing or just the records in error depends on the "Stop on Error" setting at the ENSC).

Note] in the second quarter of 2013:

- 7,800 files, containing 50 million transactions total, were submitted to AQS.
- 25% of files with Raw Data transactions had a raw data error.
- 50% of files without Raw Data had an error (e.g., site, monitor, or QA data error).
- A file with an error was re-processed (corrected and re-loaded) an average of 1.5 times.

When things go wrong the user can use the AQS 'Correct' (which is covered in the Correct section of this document) or the user can fix the data on the user's end either in the file or in the database and regenerate the file.

Type of Data in AQS

Site Data

Site information refers to the geographical location where monitoring occurs. This includes the following types of information: latitude and longitude coordinates, what geopolitical entities at location (e.g. county, city, EPA Region, etc), local site name, and street address. Information about nearby roads is also stored with the site information.

Note] Site location, site address and lat/long coordinates, is required so that operators and auditors have accurate directions to the site.

Identified by:

AQS generally list site IDs in the following way:

SS-CCC-NNNN

SS is the State FIPS (Federal Information Processing Standards) Code, CCC is the County FIPS Code, and NNNN is the Site Number within the county.

Note] leading zeros are always included.

Example:

01-089-0014

Alabama, Madison County, Site Number 14.

Tribal site IDs do not list state and county. They are listed in the following way:

TT-BBB-NNNN

TT is two capital Ts to denote Tribal, BBB is the BIA (Bureau of Indian Affairs) Tribal code, and NNNN is the Site Number within the tribal lands.

Example:

TT-007-7002

Tribal, St. Regis Band of Mohawk Indians of New York, Site Number 7002.

Required Group

Locational data is required and the AQS system will only accept Latitude/Longitude values.

Monitor Data

For the purposes of AQS, a monitor does not refer to a specific piece of equipment. Instead, it reflects that a given pollutant (or other parameter) is being measured at a given site. Monitor description information covers several different types of information about how the monitor is configured.

Such as:

When was the monitor operational? How high is the probe? Where is the probe located? How close is this monitor to the highway? What monitoring networks does it belong to? What is the objective of this monitor? Who owns and operates this monitor?

Identified by:

The site where the monitor is located, the pollutant code, and POC (Parameter Occurrence Code), which is used to uniquely identify a monitor if there is more than one device measuring the same pollutant at the same site.

For example, monitor IDs are usually written in the following way:

SS-CCC-NNNN-PPPPP-Q

Which is the Site ID plus, P P P P P being the AQS 5-digit parameter code, and Q is the POC.

For example:

01-089-0014-44201-2

Alabama, Madison County, Site Number 14, ozone monitor, POC 2.

Ambient Air Quality Data

Raw data, also called sample data, is by far the most abundant data in the database. The raw data are the individual ambient air quality measurements collected from the monitors.

Identified by:

The monitor where the measurement was taken and the time when the sample was taken.

Quality Assurance Data

Quality Assurance (QA) data consists of the set of audits that are utilized to verify that the measurement uncertainty (error) associated with sample measurements (raw data) is within acceptable limits. For the regulatory pollutants, the process is defined by Title 40 of the Code of Federal Regulations, Part 58, Appendix A. Other specialized programs, such as the Chemical Speciation Network (CSN) have their own QA requirements. AQS supports a set of QA transactions for submitting this information.

Identified by:

The monitor or lab where the quality check was taken and the date-time of the check.

Summary Data

All of the data is submitted to AQS for one primary purpose: to determine the exposure of populations to certain pollutants. Since most of the health-related measurements are couched averages of various time lengths, the system creates multiple levels of summaries of the raw data. The data is summarized on a daily, quarterly, and annual basis. Additionally, if there is a national standard for pollutant with a special averaging time (such as a running 8-hour average for example), the system will create these summarized averages as well.

Transaction Formats

The first field of all input formats is the transaction type, i.e., "RD", which indicates the type of data in the record. The second field is the Action Indicator, i.e. "I" for insert, "U" for update, and "D" for delete, which indicates the requested database manipulation action. The next block of fields is the primary key information which usually includes the State Code (or Tribal Indicator), County Code (or Tribal Code), Site ID, Parameter, and POC. It may also include assessment type or agency identifier. The combination of key fields serves to uniquely identify the record. Valid transaction types can be found at:

<https://aqs.epa.gov/aqsweb/documents/TransactionFormats.html>

Data Codes

Data codes and related user documentation can be found in the [AQS Data Coding Manual](#).

The AQS Data Coding Manual is housed on the AQS website: <https://www.epa.gov/aqs>.

Production Level Data

Browse

There are five Browse Functions, found under the Retrieval section of the Menu Bar. Each of them provides the user with read-only access to specific production level data related to the specific form. The user has the option to select a limited range of data on each of the forms by selecting specific query filters, which vary from form to form.

The five Browse Forms are:

- Annual Summary
- Approved Regional Methods
- Monitoring Seasons Parameters
- Sample Methodology

Annual Summary

The Browse Annual Summary form, found under the Retrieval section of the Menu Bar, gives the user the ability to query and browse through production-level Annual Summary Data. The user can limit the data retrieved by entering specific selection criteria on the form.

The available criteria are displayed on the form under two different tabs:

Tab: Monitor

Section: Annual Summaries

- State Code
- County Code
- Site ID
- Parameter Code
- POC
- Summary Year
- Duration Code
- EDT
- Pollutant Std
- Obs Cnt Lt Half MDL
- Observation Pct
- Geom Std Dv
- Arith Std Dv
- Geometric Mean
- Arithmetic Mean
- Min Sample Value
- Observation Cnt
- Sum Method Cnt

Direct Entry Ind
Criteria Ind
Null Data Obs Cnt
Cert Ind
Valid Day Cnt
Exp Data Cnt
Val GT Pri Std
Val GT Sec Std
Est Days GT Std
Days GT Alert Level
Non-Overlap GT
Miss Days LT Std
Req Mon Cnt
Weighted Mean
Ans Type

[Section: Summary Protocols](#)

Mp Id
Coll Freq Code
Comp Type
Alt MDL
Parameter Code
Parameter Desc
Method Code
Coll Desc
Anal Desc
Duration Code
Duration Desc
Rep Unit
Rep Unit Desc
Std Unit
Std Unit Desc

[Tab: Summary Maximums](#)

[Section: Summary Maximums](#)

Max Level
Max Sample Value
Max Coll Date

[Section: Summary Percentiles](#)

Percentile Num
Percentile Sample Value

Correct

Correct Overview

Correct within AQS is used to modify data that has been staged (uploaded) but not yet fully loaded into the AQS database. Correct only works on data that has been staged and not yet loaded.

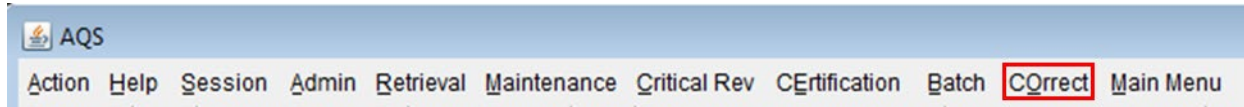

When data is submitted it is first placed in an area of the system call the "Staging Tables". Once data has been successfully processed by the AQS Load program it is no longer available to Correct.

Since each transaction is formatted differently (has a different number of fields with different content), there is a Correct form for each transaction type.

To access a correct form the user will click the Correct link in the Menu Bar, this will open a drop down menu. Here the user will select the particular form from the menu or sub-menu.

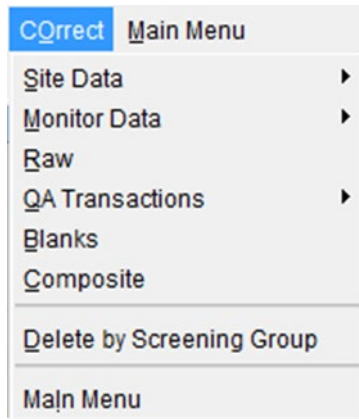

Under Site Data:

- Site
- Open Path
- Tangent Road
- Site Sampler
- Sampler Channel

Under Monitor Data:

- Monitor
- Samp Period
- Types
- Objectives

- Samp Schedule
- Probe Obs
- Reg Compliance
- Collocation
- Protocol
- Agency
- Tangent Road
- Monitor Network Affiliations
- Primary Monitor Period
- Monitor Channel
- Monitor Method
- Monitor Exclusion

Under QA Transactions:

- One Point QC
- Annual Performance Evaluation
- Semi Annual Flow Rate Audit
- Flow Rate Verification
- PM-Coarse Flow Rate Verification
- PM Coarse Semi Flow Rate Audit
- Performance Evaluation Program
- NPAP
- Field Proficiency Test
- Duplicate
- Replicate
- Speciation Flow Rate Verification
- Speciation Semi Annual Flow Rate Audit
- Pb Analysis Audit
- Lab Proficiency Test
- Ozone SRP and Standard Transfer Verifications
- Ambient Air Protocol Gas Verification Program

Rows Errors

The Row Errors block in the form indicates the errors or conditions on the current Correct Form row that prevented that data from properly loading.

The data displayed on the Row Errors screen is for display only (errors may not be updated or deleted) and applies only to the currently selected Correct row. Row Errors will not exist for data records being inserted.

Correct Monitor Agency Roles

To access the Correct Monitor Agency Roles form the user will click the Correct link in the Menu Bar, this will open a drop down menu. Here the user will select Monitor Data from the menu then the user will select Monitor Agency Role from the sub-menu.

The Correct Monitor Agency Roles form provides the capability to correct data that failed at least one table constraint validation and therefore could not be inserted into the production tables.

This form will display the erroneous monitor agency role data and any associated errors for the currently selected data record.

Correct Monitor Collocations

To access the Correct Monitor Collocations form the user will click the Correct link in the Menu Bar, this will open a drop down menu. Here the user will select Monitor Data from the menu then the user will select Collocation from the sub-menu.

The Correct Monitor Collocations form provides the capability to correct Monitor Collocation data that failed at least one table constraint validation and therefore could not be inserted into the production tables. This form will display the erroneous monitor collocation data and any associated errors for the currently selected data record.

Correct Monitor Objectives

To access the Correct Monitor Collocations form the user will click the Correct link in the Menu Bar, this will open a drop down menu. Here the user will select Monitor Data from the menu then the user will select Objective from the sub-menu.

The Correct Monitor Objectives form provides the capability to correct Monitor Objective data that failed at least one table constraint validation and therefore could not be inserted into the production tables. This form will display the erroneous monitor objective data and any associated errors for the currently selected data record.

Correct Monitor Regulation Compliances

To access the Correct Monitor Regulation Compliances form the user will click the Correct link in the Menu Bar, this will open a drop down menu. Here the user will select Monitor Data from the menu then the user will select Reg Compliance from the sub-menu.

The Correct Monitor Regulation Compliances form provides the capability to correct Monitor Regulation Compliance data that failed at least one table constraint validation and therefore could not be inserted into the production tables. This form will display the erroneous monitor regulation compliance data and any associated errors for the currently selected data record.

Correct Monitor Tangent Roads

To access the Correct Monitor Tangent Roads form the user will click the Correct link in the Menu Bar, this will open a drop down menu. Here the user will select Monitor Data from the menu then the user will select Tangent Road from the sub-menu.

The Correct Monitor Tangent Roads form provides the capability to correct Monitor Tangent Roads data that failed at least one table constraint validation and therefore could not be inserted into the production tables. This form will display the erroneous monitor tangent road data and any associated errors for the currently selected data record.

Correct Monitor Types

To access the Correct Monitor Types form the user will click the Correct link in the Menu Bar, this will open a drop down menu. Here the user will select Monitor Data from the menu then the user will select Types from the sub-menu.

The Correct Monitor Types form provides the capability to correct Monitor Types data that failed at least one table constraint validation and therefore could not be inserted into the production tables. This form will display the erroneous monitor type data and any associated errors for the currently selected data record.

Correct Monitor

To access the Correct Monitor form the user will click the Correct link in the Menu Bar, this will open a drop down menu. Here the user will select Monitor Data from the menu then the user will select Monitor from the sub-menu.

The Correct Monitor form provides the capability to correct Monitor data that failed at least one table constraint validation and therefore could not be inserted into the production tables. This form will display the erroneous monitor data and any associated errors for the currently selected data record.

Correct Probe Obstructions

To access the Correct Probe Obstructions form the user will click the Correct link in the Menu Bar, this will open a drop down menu. Here the user will select Monitor Data from the menu then the user will select Probe Obs from the sub-menu.

The Correct Probe Obstructions form provides the capability to correct Probe Obstruction data that failed at least one table constraint validation and therefore could not be inserted into the

production tables. This form will display the erroneous probe obstruction data and any associated errors for the currently selected data record.

Correct Sample Periods

To access the Correct Sample Periods form the user will click the Correct link in the Menu Bar, this will open a drop down menu. Here the user will select Monitor Data from the menu then the user will select Samp Period from the sub-menu.

The Correct Sample Periods form provides the capability to correct Sample Period data that failed at least one table constraint validation and therefore could not be inserted into the production tables. This form will display the erroneous sample period data and any associated errors for the currently selected data record.

Correct Sample Schedules

To access the Correct Sample Schedules form the user will click the Correct link in the Menu Bar, this will open a drop down menu. Here the user will select Monitor Data from the menu then the user will select SAMP Schedule from the sub-menu.

The Correct Sample Schedules form provides the capability to correct Sample Schedule data that failed at least one table constraint validation and therefore could not be inserted into the production tables. This form will display the erroneous sample schedule data and any associated errors for the currently selected data record.

Correct Site

To access the Correct Sample Schedules form the user will click the Correct link in the Menu Bar, this will open a drop down menu. Here the user will select Monitor Data from the menu then the user will select SAMP Schedule from the sub-menu.

The Correct Sample Schedules form provides the capability to correct Sample Schedule data that failed at least one table constraint validation and therefore could not be inserted into the production tables. This form will display the erroneous sample schedule data and any associated errors for the currently selected data record.

Correct Open Paths

To access the Correct Open Paths form the user will click the Correct link in the Menu Bar, this will open a drop down menu. Here the user will select Site Data from the menu then the user will select Open Path from the sub-menu.

The Correct Open Paths form provides the capability to correct Site Open Path data that failed at least one table constraint validation and therefore could not be inserted into the production tables. This form will display the erroneous site open path data and any associated errors for the currently selected data record.

Correct Site Tangent Road

To access the Correct Sites Tangent Roads form the user will click the Correct link in the Menu Bar, this will open a drop down menu. Here the user will select Site Data from the menu then the user will select Tangent Road from the sub-menu.

The Correct Sites Tangent Roads form provides the capability to correct Site data that failed at least one table constraint validation and therefore could not be inserted into the production tables. This form will display the erroneous site tangent road data and any associated errors for the currently selected data record.

Correct Raw Data

This section covers how to correct Raw Data.

Note] correcting other transaction types (with the exception of QA, which is described later) will work identically.

Procedure Overview

1. The user will select the correct form from the menu or sub-menu
2. The user will query the data requiring correcting from the AQS database
3. The user will edit the data
4. The user will save the data back to the AQS staging area

Open Correct Raw Data Form

To access the Raw Data Form the user will click the Correct link in the Menu Bar, this will open a drop down menu. Here the user will click the Raw link from the menu.

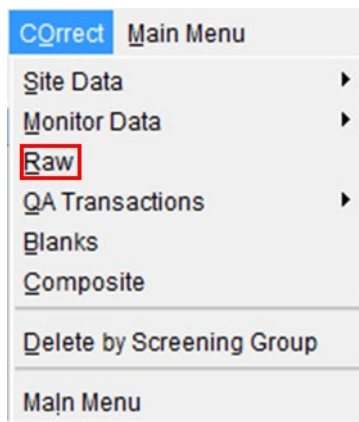

This will open the Raw Data Form.

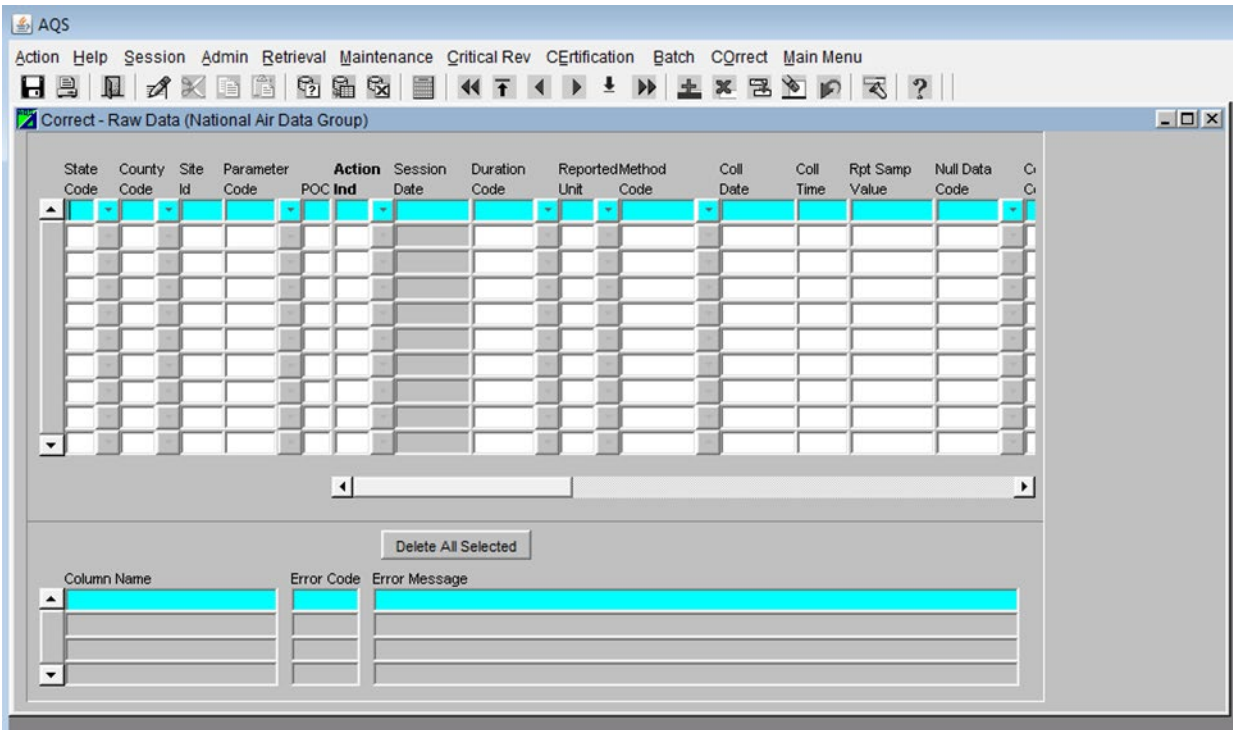

Query Data

The user will query data from the database in to the form.



The principle buttons used for query operations are:

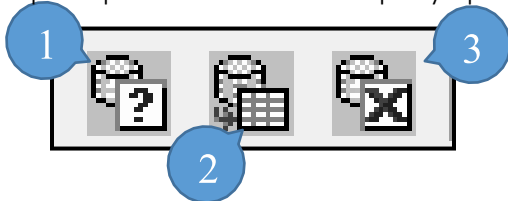

(1) Enter Query (2) Execute Query (3) Cancel Query

Enter Query

When the form opens it defaults to query mode as evidenced by “Enter Query” in the status bar at the bottom. It assumes the user wants to bring data from the AQS database into the form and allows the

user to query all data or limit the data by inputting specific parameters. If the user would prefer to enter data manually then the user must click the cancel query button. However, once the user has begun to enter data manually the query function is no longer available unless the user clears the form.

The purpose of the Enter Query function is to bring data from the database into the form, edit it, and save it back into the AQS database.

Entering values into any field will allow the user to narrow searches. For example, if the user wanted only data for a specific state, the user would enter the corresponding a state code. If the user wanted data for just one parameter in a specific state the user would enter the state code and a parameter code.

A correct form will never bring back data not loaded by the user’s screening group.

Once the user has entered query criteria the user will execute the query to bring the data from AQS into the form.

Execute Query

This button retrieves all of the user’s screening group data, matching the query criteria, into the Correct form. If no query criteria was entered all data from the screening group will be returned.

Note] all records in the staging tables the match the query criteria will be returned. In the old-style correct forms, there is no way to retrieve only the data that was submitted in a specific file.

To retrieve all the queried data to the form the user will click the Last Record button, otherwise the data is retrieved on screen/page at a time.

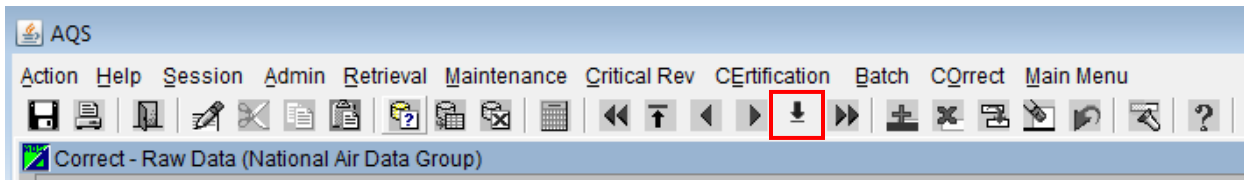

The status bar at the bottom left of the screen will display the number of records retrieved from the database to the form.

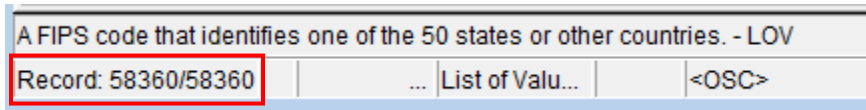

Cancel Query

This button cancels any active query and cancels the query mode.

The user may need to use this button to execute a second query if the first returned no data. After the user has executed a query with no results the Cancel Query button should be clicked then clicking the Enter Query button will allow the user to enter new criteria.

Edit Data

Once the data is in the form changes can be made to it. There are two ways to do this.

Edit options

1. Type Over

Edit the data field by field (box by box) on the screen. The user will select text or place the cursor where necessary and insert, delete, or replace text.

2. Global replace

Perform a "search and replace" in a single column. The user does this by placing the cursor in the value to be replaced.

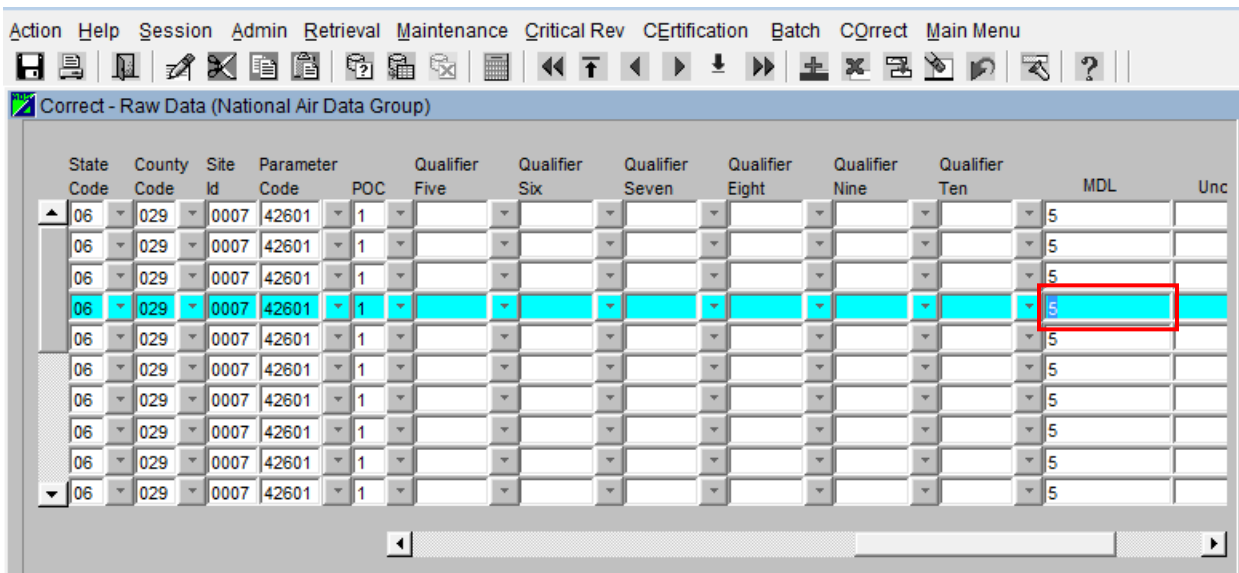

Then presses the Search and Replace icon.

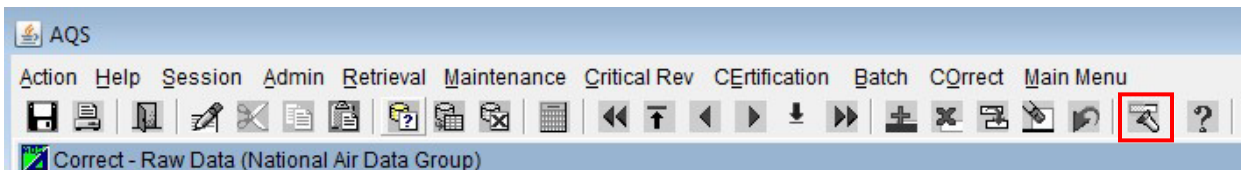

This will bring up a window that will allow the user to replace every occurrence in that column for all data retrieved by the query.

Note] this operation does not work like any other program; "Replace" and "Replace All" replace every value in that column with the new value, not just the ones with the "Current Value".

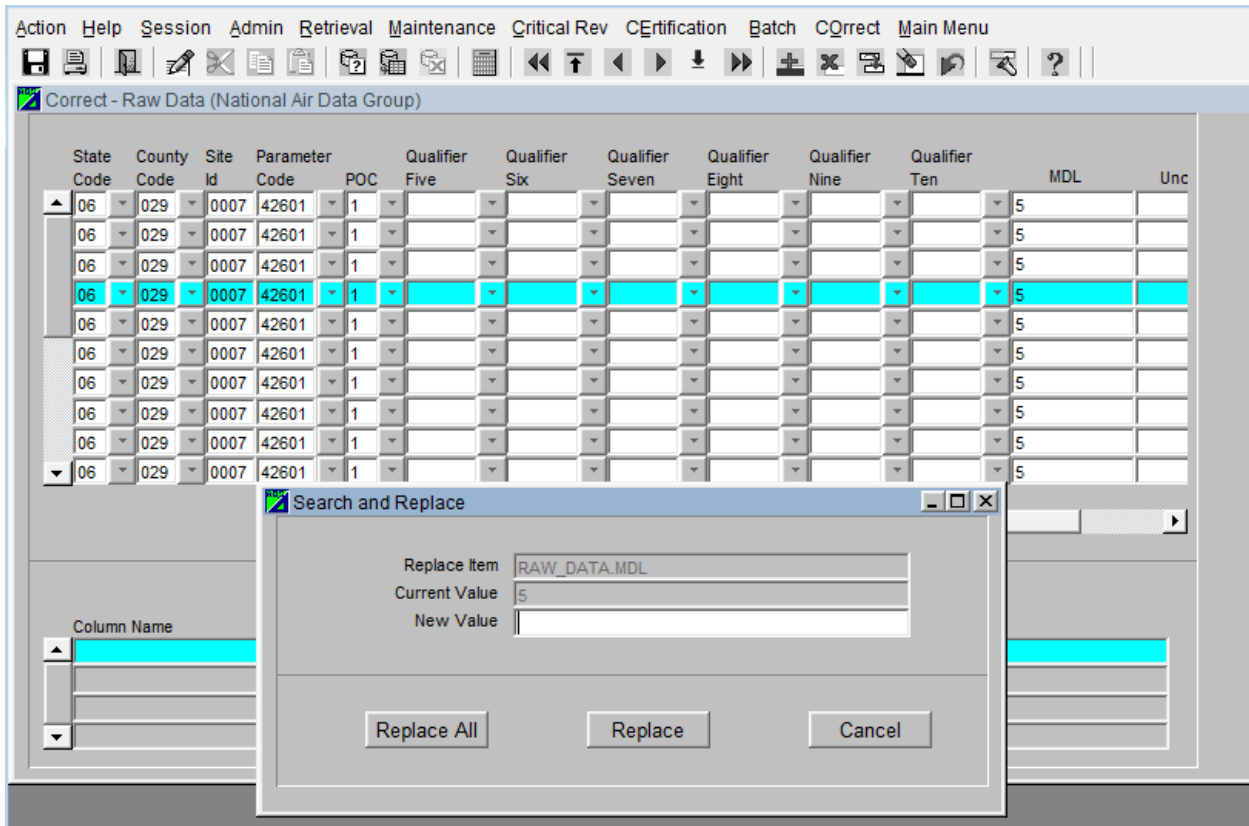

Search and Replace

Search and Replace allows the user to search within the specified column and replace specific values with a new value or to replace all values in the column with a new value.

The Replace Item is automatically populated with the name of the column the user was on before launching the Search and Replace. The Current Value field is automatically populated with the value of the column the user was on prior to launching the search and replace.

Save the Data

After the data has been edited it is still only in the form until it is saved. Clicking the save icon will save the changes to the database.

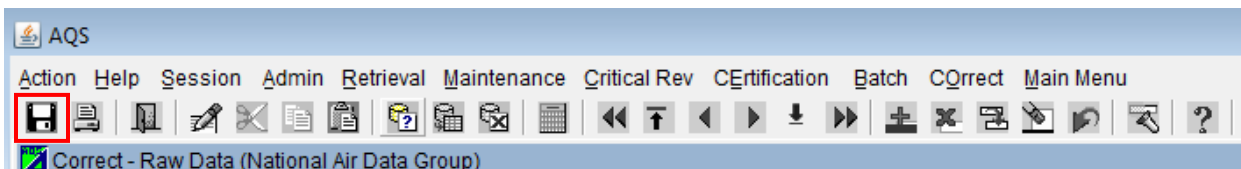

Other Correct Features

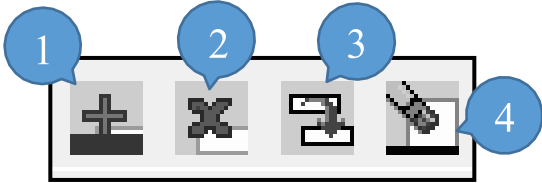
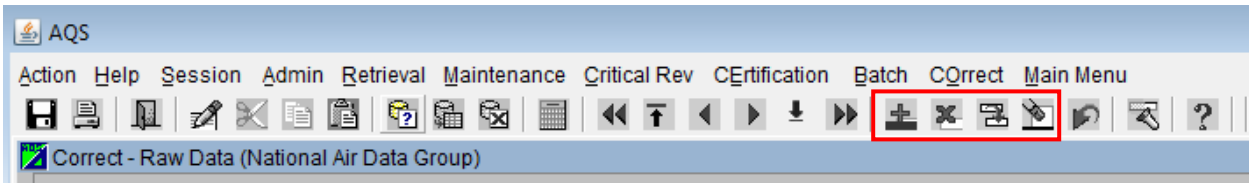

(1) Insert Record (2) Remove Record (3) Duplicate Record (4) Clear Record

Insert Record: Inserts a new blank record after the highlighted one. **Remove**

Record: Deletes the highlighted record.

Duplicate Record: Duplicates a record.

Clear Record: Deletes all of the contents of the fields, but not the record.

Note] when transactions are inserted, they are associated with an “on-line” session rather than a previously submitted file. On the Batch form they will be in a file named “ONLINE_UUU_NNNN”; where “UUU” is the user’s AQS user-id and ‘NNNN’ is a unique number.

The Delete All Selected button

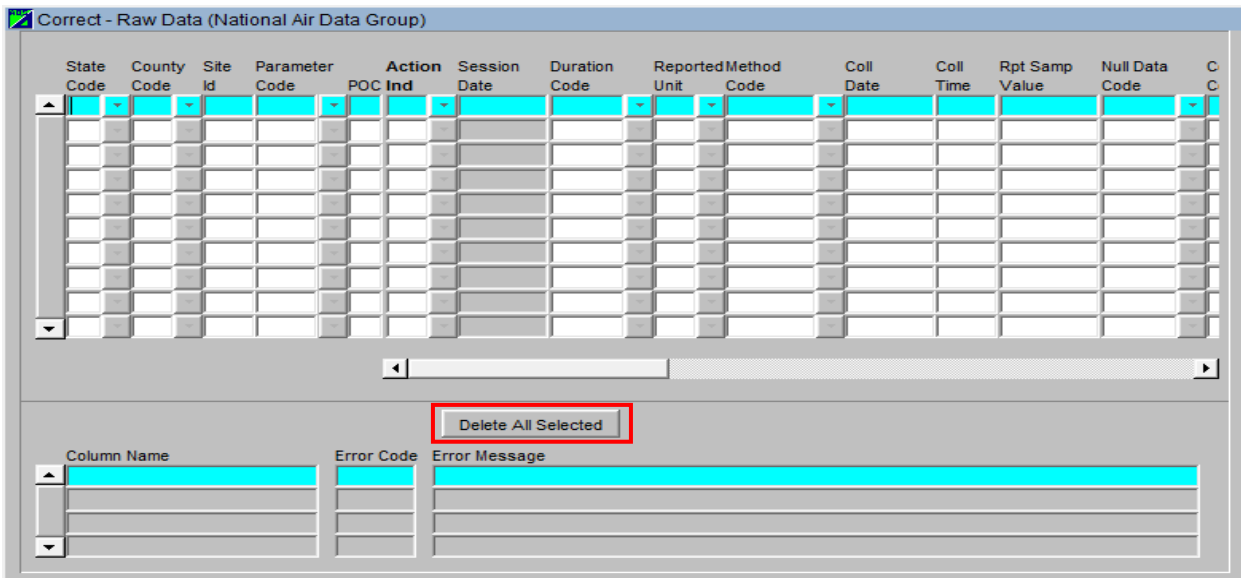

This button deletes all records that were returned by the query.

Note] this deletes all records that are listed in the display not just the selected records on the screen.

Correct One-Point QC

This section covers how to correct 1-Point QC transactions. The procedure will be identical for all other QA transactions.

Select the Correct / QA Transactions / One-Point QC menu pick.

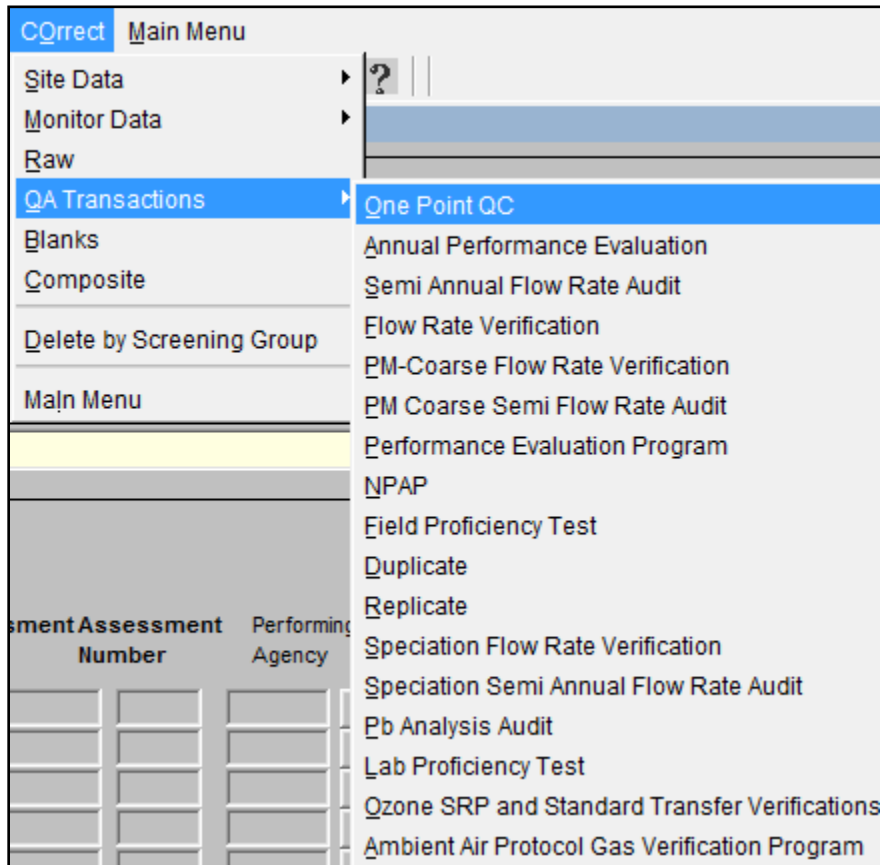

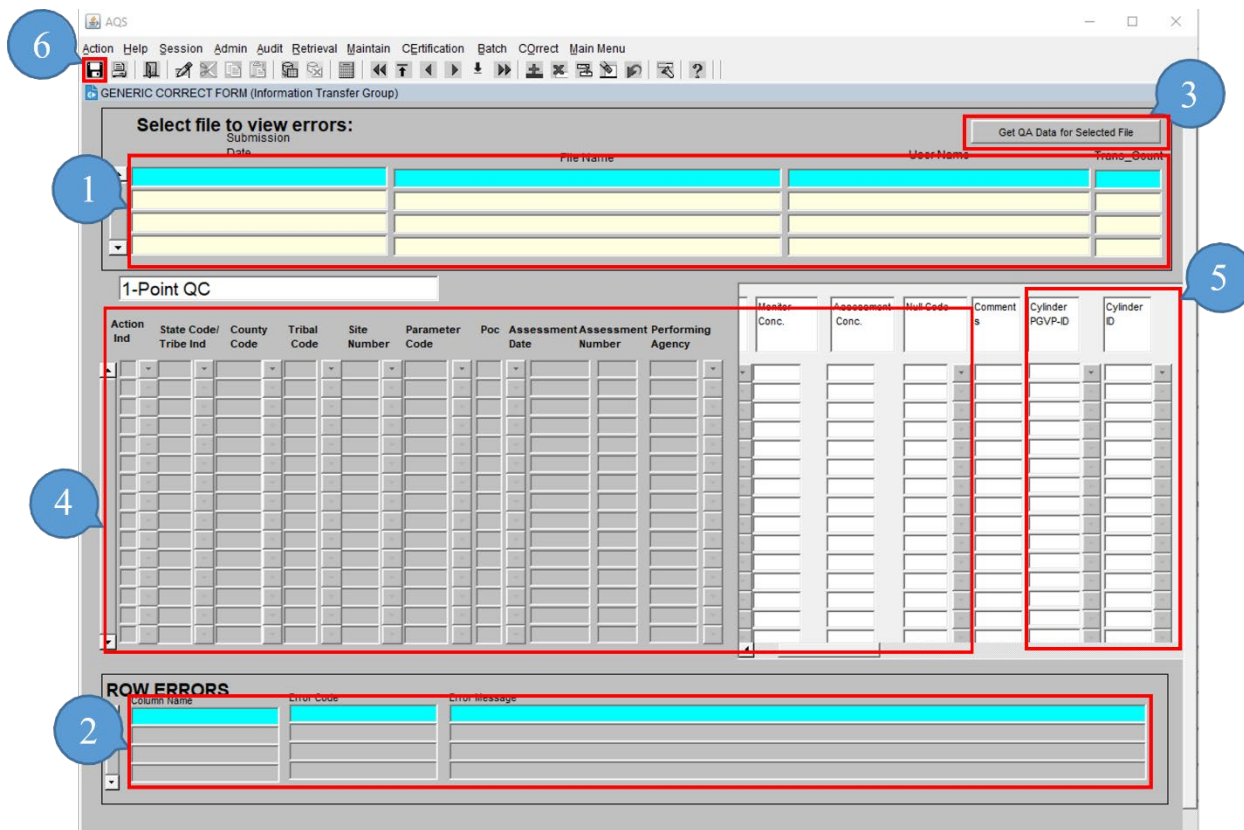

1. The User will select the file with errors to be corrected
2. Error Messages for the selected transactions will show up in the Row Errors section
3. Then click the “Load QA Data” button
4. Edit the data retrieved (and/or insert new records)
5. New: Cylinder PGVP-ID and Cylinder ID fields for users to identify cylinders and producers
6. Click the Save icon

Correct Composite Data

The Correct Composite Data form, found under the Correct section on the Menu Bar, will display the erroneous composite data and any associated errors for the currently selected data record.

This form allows the user to correct information about the concentrations of various air pollutants measured by air monitoring equipment for multiple samples that are combined and analyzed as a single sample that failed at least one table constraint validation and therefore could not be inserted into the production tables. This form allows the user to query and correct

any data associated with the user's screening group. Data may be inserted, updated, or deleted on this form.

Correct Highlights

- Only data that has not yet been loaded into AQS (the staging tables).
- The user can only see data in the user's respective screening group.
- All changes must be saved (including deletes).

Submitting Corrected Data

After the user has made the changes and saved them using the correct forms the data will need to be loaded into AQS. In order to do this the user will:

1. Go back to the Batch form.
2. Highlight the records associated with the file whose data was being corrected.
3. Press the Load File or Post File buttons, depending on what processes needs to be ran.

The process status and the Load and Post record counts will update just as for any other batch process.

On-Line Data Tools – Maintain

Maintain Overview

Maintain allows the user to:

1. Enter new data into the database (without having to go through the batch load process)
2. Edit data in the database (i.e. Insert, Update, or Delete)

Correct and Maintain are very similar in operation - they are a series of forms that allow you to edit data.

There are also a few important differences between Correct and Maintain:

Correct	Maintain
Operates on data not yet loaded into AQS	Operates directly on the AQS database
Forms mirror the structure of the text transactions	Forms mirror the structure of the AQS database
Generally, one row for each transaction	Forms are laid out to be easier to read and contain more data
Data not checked for errors until it is Loaded	Data checked for errors when it is saved
User can only see data in respective screening group	If logged in as read only, the user can see any production status data

Maintain is useful for the following tasks:

1. Creating site and monitor records.
 - a. Lists-of-values make it unnecessary to know codes
 - b. Site form has Check Completeness and Create Monitor buttons
 - c. Monitor form has Check Completeness and Duplicate monitor buttons
 - d. Each "subordinate" record is displayed as a separate tab
 - e. The user can close monitor by entering a close date and saving the record – all subordinate records will automatically be populated with end dates.
2. Entering small amounts of data into AQS.
 - a. Data you would rather type than create a transaction and use the load process for
 - b. Data that you don't have transactions for
3. Entering data for which there are not transactions defined
 - a. E.g. Events

Maintain Site

1 Basic Site Data | Additional Site Data | Agency Roles | Tangent Roads | Open Paths | Comments | Primary Monitor Periods

2 Lookup Geography

3 Check Validity

4 Create Monitor

1. The only User Datum allowed for New Sites is WGS84 and the Lookup Geography button will only work when the . User Datum field is set to WGS84.
2. Standard Coordinates and UTM Data are provided for historical purposes only.

The Maintain Site form is used to enter or edit all data relating to a site. This includes data from the site basic transaction and all of the site subordinate transactions.

- (1) On this form, data from each transaction type is included under a separate tab.
- (2) Lookup Geography button allows the geographic coordinates in latitude and longitude to be entered. When this button is clicked, the EPA standard coordinates (lat/lon in the WGS84 datum) are calculated and populated. Also, much of the other geographic data is populated (city, zip, etc.)
- (3) The Check Completeness button can help the user determine if AQS thinks that data needed to make a site "complete" is present. This is a convenience to help the user keep track of what to do next but does not have to be used.

- (4) Once the user has completely entered (and saved) site data, the user may create a monitor with as much data as possible pre-populated in the Maintain Monitor form by clicking the Create Monitor button.

Maintain Monitor

This is found under the Maintain section on the Menu Bar then select Monitor. It provides the ability to directly view all monitor data in the database when the user has selected (or defaulted to) the Read Only Screening Group Monitor information is maintained in the database to describe the pollutants measured at the Air Quality Monitoring Station.

The term "monitor" may be misunderstood. In AQS the term does not refer to a device but to the pollutant measured by a device.

The Maintain Monitor form is also used to enter or edit all data relating to a monitor. Data security rules are enforced so that only the owner of the data has modify access to their data. This includes data from the monitor basic transaction and all of the site subordinate transactions.

- (1) On this form, data from each transaction type is included under a separate tab.
- (2) The Check Completeness button can help the user determine if AQS thinks that data needed to make a monitor "complete" is present. This can be more convenient than attempting to save the record and getting a series of errors.
- (3) Once the user has completely entered (and saved) data for a monitor the user may create a duplicate of that monitor with as much data as possible pre-populated in the Maintain Monitor form by clicking the Duplicate Monitor button. This is convenient for creating a collocated monitor, or series of speciation monitors, etc

Entering New Monitor Data

To create a new monitor record in the database the user will need to edit query mode before entering data in the various fields. This is done one of in three ways:

<Cancel Query> will put the user in data input mode.

<Insert Record> will give the user a blank form to enter data. This is often used when monitor records have already been selected.

<Duplicate Monitor button> will make a copy of the monitor currently displayed in the form. The user will be prompted to enter a new Parameter or POC. Most of the values of the monitor data visible when clicked on the Duplicate Monitor button will be copied to the new monitor record.

To maintain the Agency Roles, Sampling Periods, Objectives, Monitor Types, Tangent Roads, Probe Obstructions, Regulation Compliance, Required Collection Frequency, Collocation, or Comments data associated with the selected Monitor record, the user will select the corresponding tab.

Agency Roles

This is found under the Maintain section on the Menu Bar then select Monitor then the Agency Roles tab. All agency roles now require begin dates. Legacy data only required begin dates for REPORTING roles. Modification of any legacy monitor data will force the setting of begin dates for all roles before a save will be executed.

The Monitor Agency Roles tab allows the user to insert or update production Agency Role data associated with the Monitor record that the user selected in the Monitor Basic tab. All existing Agency Role records are displayed when the tab is opened. The user can insert or update Agency Role data in this module. However, Agency Role data is deleted through batch submittal.

Maintain Event

Maintain Exceptional Events (National Air Data Group)

Define Event | Associate Raw Data with Event

Screen Grp Name: National Air Data Group

Qualifier Code	Qualifier Description	Event Begin Date	Event End Date
<input type="text"/>	<input type="text"/>	<input type="text"/>	<input type="text"/>

Event Description:

Comment:

Url:

Exceptional events do not have a transaction type in AQS. Therefore the Maintain Event form must be used to enter and update event information that will be used to apply for exclusions.

Maintain Precision

The screenshot shows a software window titled "Maintain Precision Data (National Air Data Group)". The window contains a data entry form with the following fields:

- State
- County
- Site
- Parameter
- POC
- Begin Date
- End Date
- Precision Date
- Precision Id
- Precision Sample Id
- Precision Data Type
- Indicated Method
- Indicated Unit
- Indicated Duration
- Indicated Value
- Actual Method
- Actual Unit
- Actual Duration
- Actual Value

The user will likely use this form to enter or edit QA data.

Maintain Accuracy

Accuracy Data

State County Site Parameter POC Begin Date End Date

Audit Type Auc Audit Class Acc Date Year Qtr Accuracy Type

Local Pri Std Audit Sample Id Expiration Date Audit Scheduled Zero Span Value

Monitor Protocol

Method Unit Duration

Accuracy Audits

Audit Id

Previous Next

Level Number	Actual Value	Indicated Value

The user will likely use this form to enter or edit QA data.

Maintain Comments

Comments are associated with Sites, Monitors, Raw Data qualifiers (they are attached to the qualifier code, not the raw data value itself) and Composite Data qualifiers. The Maintain Comments screen (or tab, depending on the form) allows you to insert or update Comments associated with the record that you selected. All existing Comment records are displayed when the screen is opened.

Maintain Site

This section describes how to use the maintain forms to create a new site in AQS.

How to use Maintain

The procedure for using Maintain is the same as for Correct.

1. The user will open the maintain form
2. Query the data to edit from the AQS database into the form
3. Edit the data
4. Save the data back to the AQS database

To enter new data (rather than query old data) the user will click the Cancel Query icon and begin entering new data.

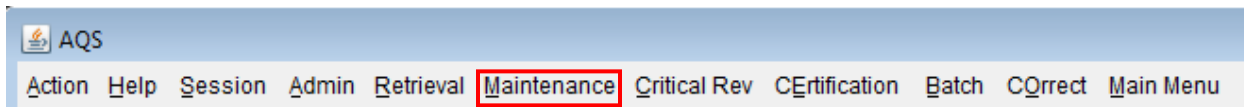

To access a maintain form the user will click the Maintain link in the Menu Bar, this will open a drop down menu. Here the user will select the particular form from the menu or sub-menu.

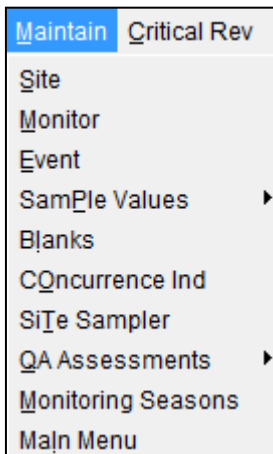

Under Sample Values:

- Raw Data
- Composite Data
- Delete Production Data

Under QA Assessments:

- 1-Point QC
- Field Proficiency Tests

- Flow Rate Verification
- PEP
- Semi Annual Flow Rate Audit
- Annual Performance Evaluation
- NPAP Assessment
- Duplicate Assessment
- Replicate Assessment
- PMc Flow Rate Verification
- PMc Semi Flow Rate Audit
- Speciation Flow Rate Verification
- Speciation Semi Annual Flow Rate Audit
- Lead Analysis Audit
- Lab Proficiency Test
- AA-PGVP Assessment
- Ozone SRP Assessment
- Audits of Data Quality
- Technical Systems Audits
- QA Project Plans
- Quality Management Plans

Enter Site Basic Info

To access the Site form the user will click the Maintain link in the Menu Bar, this will open a drop down menu. Here the user will select Site from the drop down menu.

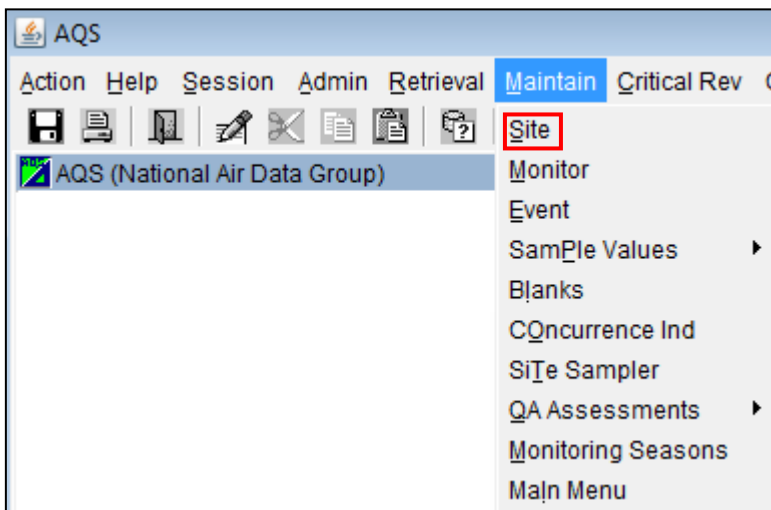

To create a new Site the user will first click the Cancel Query icon.

[Interactive Training – Create a New Site](#)



The user then needs to fill in all of the required fields. Required fields are indicated by the bolding of the field name.

Note] on this form, there are very few non-bolded fields.

Once all of the required fields are populated the user should click the Save icon.

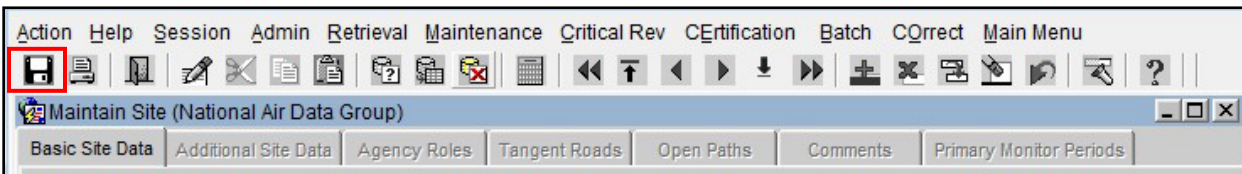

The status bar (at the bottom left of the screen) should indicate that a record has been applied and saved.

At this point the site is still incomplete as additional information is required, such as Supporting Agency Role and at least one Monitor record.

Status Indicators

On the Basic Site Data tab the Status Ind(icator) field will show a value of "F".

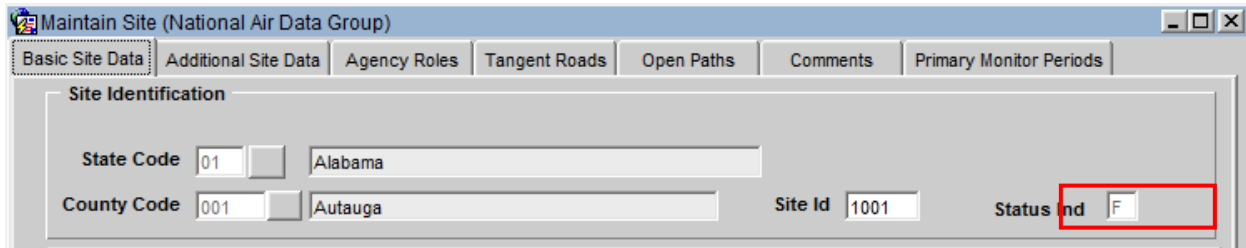

The screenshot shows a software window titled "Maintain Site (National Air Data Group)". It has several tabs: "Basic Site Data", "Additional Site Data", "Agency Roles", "Tangent Roads", "Open Paths", "Comments", and "Primary Monitor Periods". The "Basic Site Data" tab is selected. Under the "Site Identification" section, there are two rows of input fields. The first row has "State Code" with a dropdown menu showing "01" and a text box containing "Alabama". The second row has "County Code" with a dropdown menu showing "001" and a text box containing "Autauga". To the right of these are "Site Id" with a text box containing "1001" and "Status Ind" with a dropdown menu showing "F". The "Status Ind" dropdown is highlighted with a red rectangular box.

Status Indicators are very important in AQS. Every time data is put into AQS the system performs a variety of checks on that data:

1. Is each value a valid value (within acceptable ranges)?
2. Is the format correct (e.g., number versus text)?
3. Are mandatory fields present?
4. Is prerequisite data present (e.g., a monitor must exist before raw data can be loaded)?
5. Is co-requisite data present (e.g., a site must have a Supporting Agency Role, a raw data value must have a Sample Begin Time)?
6. Did raw data undergo the Statistical and Critical Review checks?

Depending on the answers to these questions, (almost) all incoming data is assigned a Status Indicator. This value may change as the data progresses through software checks.

Status Indicators and their meanings:

Status Indicator	Status	Meaning
F	Fields Valid	The individual data elements (fields) are valid (ranges, formats, etc.).
R	Relationally Valid	Prerequisite and co-requisite data is present and complete.
S	Stats Checked	This data has been through the Statistical and Critical Review process.
I	Inactive	This data is no longer relevant. We inactivate some data rather than delete it to keep audit trails.
P	Production	This data is has successfully been submitted to AQS. The reporting requirement has been met. This data is available to anyone.

Enter an Agency Role

The user will click the Agency Roles tab. This will open up the Agency Roles form. The user will populate the Agency Role, Agency Code, and Begin Date fields. Once this is complete the user should click the save icon and verify that the save was successful on the status bar.

Agency Role	Agency Code	Agency Desc	Begin Date	End Date
▲ SUPPORTING	1108	US EPA/OAQPS	20010101	

Create a Monitor

To create a monitor the user will click the Create Monitor button at the bottom of the Basic Site Data tab from the Maintain Site form or access the Maintain Monitor from the Maintenance menu.

Maintain Site (National Air Data Group)

Basic Site Data | Additional Site Data | Agency Roles | Tangent Roads | Open Paths | Comments | Primary Monitor Periods

Site Identification

State Code: 01 Alabama
County Code: 001 Autauga Site Id: 1001 Status Ind: F

User Coordinates

Horizontal Datum: NAD27 Latitude: 32.5367 Longitude: -86.6483
UTM Zone: UTM Easting: UTM Northing: Lookup Geography

Standard Coordinates: Datum: NAD83 Latitude: 32.536872 Longitude: -86.648285

Horizontal Method: 103 GPS
Horizontal Accuracy (Meters): 50 Source Map Scale (Non-GPS):
Vertical Measure (Meters): 50 Vertical Accuracy (Meters): 50 Vertical Datum: MEAN SEA-L
Vertical Method: 008 OTHER

Street Address: 889 Love Ln
Land Use Type: COMMERCIAL Location Setting: RURAL
City Code: Urban Area Code:
AQCR Code: 002 COLUMBUS-PHENIX CITY
Site Established Date (YYYYMMDD): 20010101 Time Zone Name: CENTRAL
Owning Agency: 1108 US EPA/OAQPS

Check Completeness **Create Monitor**

[Interactive Training – Create a New Monitor](#)

Once this button is clicked either of these will cause AQS to open the Monitor Basic tab of the Maintain Monitors form.

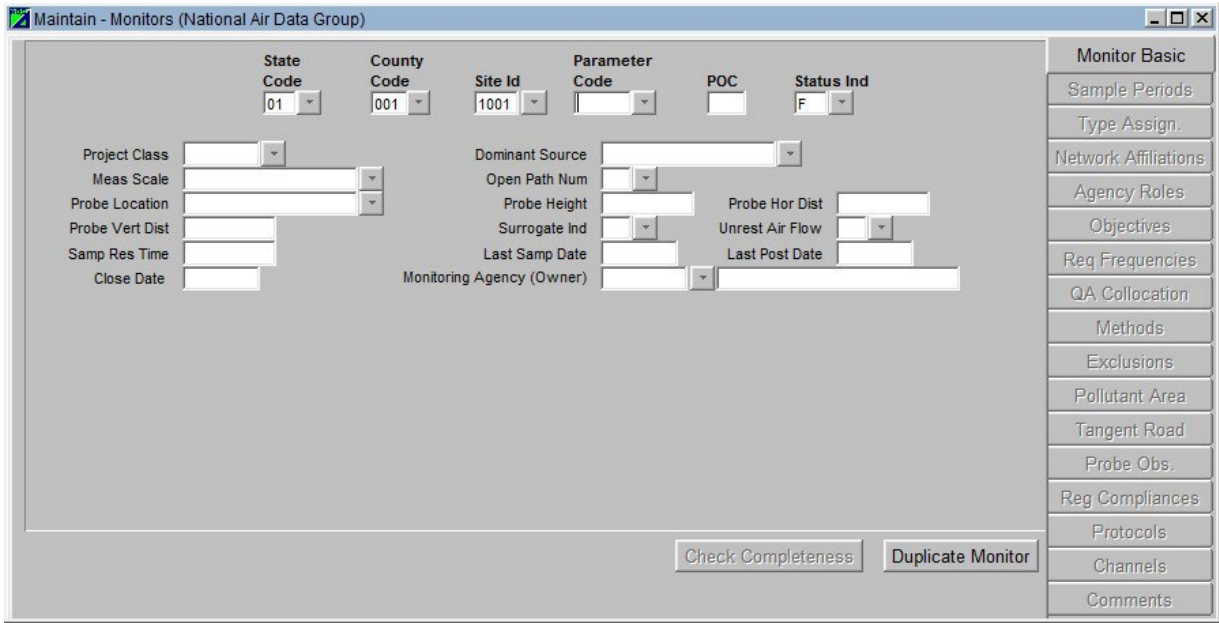

Once all mandatory data is entered in this tab (by adding Parameter Code and POC (Parameter Occurrence Code)) then remainder of the tabs become available for editing (go from grayed out to selectable).

Note] on this form, the Save icon is grayed out (not selectable) until you enter all mandatory fields.

Note] that the Check Completeness button stays grayed out even though the required Monitor Basic information is populated. To activate the Check Completeness button the user must navigate away from the Monitor Basic tab and back to it.

To complete data entry for the monitor the user can either click on each of the tabs and fill in the required fields (indicated with bold field names) or click the Check Completeness button for a to-do list. Once all required fields are populated the user should click the Save icon.

The following are a brief description of each of the tabs on the form:

Sample Periods: Sample periods are the time periods (date ranges) of operation of a monitor. (Required for all monitors)

Type Assign: The Type Assignments is the administrative classification of the monitor. (Required for all monitors) Possible values are:

- SLAMS: State and Local Air Monitoring Station: Regulatory monitor operated by a state or local agency.
- SPM: Special Purpose Monitor: A monitor for a regulated parameter but that is not used for meeting the minimal requirements of Part 58.
- TRIBAL: Regulatory monitor operated by a recognized Native American tribe.

- INDUSTRIAL: Monitor operated by an industrial organization (rather than a governmental organization)
- EPA: Monitor operated by the EPA itself.
- NON-EPA FEDERAL: Monitor operated by another Federal Agency.
- OTHER: Monitor for a pollutant/parameter not required by Part 58. (i.e. not addressed by the Clean Air Act)

Network Affiliations: Optional. Network program under which the monitor is operated. e.g. N CORE or PAMS.

Agency Roles: The real-world organizations/agencies with specific responsibilities for a monitor. (Required for all monitors) Possible values are as follows:

- PQAQ: Primary Quality Assurance Organization – Agency responsible for QA of the monitoring process at the monitor. Required
- Reporting: Agency responsible for submitting the sample measurements for the monitor to AQS. Required. They have the following rights:
 - Access Maintain Raw measurement data
 - Submit RAW data and Routine QA data-
- Collecting: Agency that collects samples from the monitor (if different from the above) Optional
- Analyzing: Agency that analyzes samples from the monitor (if different from the above) Optional
- Certifying: Agency responsible for sending an annual letter to the EPA that the data submitted to AQS for the monitor is complete and correct. Required for monitors required by Part 58.
- Audit: Agency responsible for submitting Quality Assurance audits to AQS. For the National Performance Evaluation programs (Part 58 Appendix A 2.4). Agencies may be approved to “self-implement” the program. (Multiple allowed at a monitor at any given time)
- Support: Any agency that is designated by owner that is allowed to make changes to the site metadata. Indicates the agency responsible for the site. Applies to Site only.

Objectives: The purpose for measuring air quality data by the monitor. (Required for monitors defined in Part 58)

Req Frequencies: For manual method monitors (e.g. filter based monitors), how often the monitor collects samples. Required for all manual method monitors.

QA Collocation: If the monitor is paired with another monitor for Quality Assurance (as defined in Part 58 Appendix A), this provides the date range and defines whether the monitor is the primary monitor or the QA monitor. Optional.

Methods: This defines the sampling and analysis method used to analyze monitor data.
Required.

Exclusions: Used to indicate that the monitor is excluded from Design Value calculations.
Optional

Pollutant Area: Used to indicate the administrative area (e.g. Monitor Planning Area) associated with the monitor. Optional

Tangent Road: Used to indicate the distance to roads that are adjacent to the monitoring site.
Optional

Probe Obs: Used to indicate that there is an external object that obstructs the free flow of air to the monitor. Optional

Reg. Compliance: Used to indicate the date when the monitor met the requirements of each of the appendices of Part 58. Optional

Protocols: Informational Only. Used to indicate if there is an alternate method detection limit for the method used by the monitor. Optional

Channels: For monitors associated with speciation analysis (i.e. analysis of the chemicals on a filter), this indicates which sampler and channel on the sampler is used by the monitor. Optional

Comments: Free form text. Optional

Maintain Blanks

The user will find this under the Maintain section on the Menu Bar. The Maintain Blanks form displays all blanks data for the Screening Group. Unlike similar forms in the AQS application the top block in the form that is used for selection does not control the display area below once the select has been done. All blanks data for all monitors selected is displayed.

Blank data is the record of the pre-use value for filters or other similar components used in monitors. The "tare" value is another term that is used to describe this value.

Protocol information describes the method, unit, and duration used to determine the blank value. This does not have to be the same as the protocol used by the monitor to report pollutant values.

Add Site Samplers

To access the Site Samplers form the user will click the Maintain link in the Menu Bar, this will open a drop down menu. Here the user will select Site Sampler from the drop down menu.

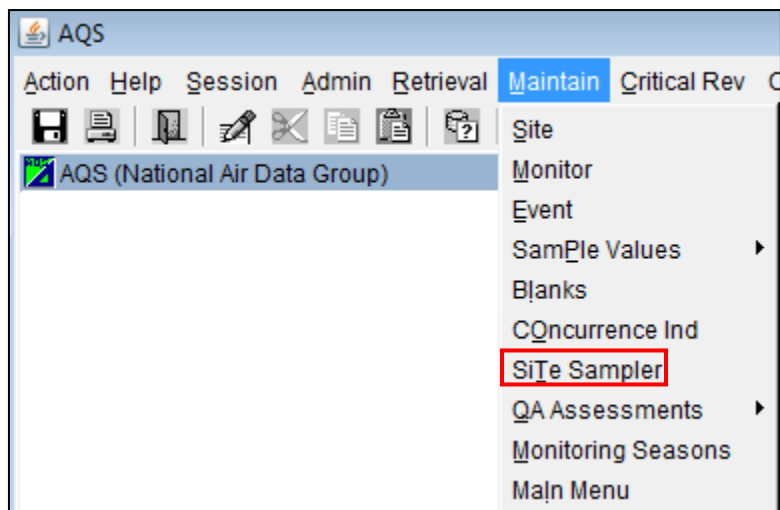

To create a new Site Sampler the user will first click the Cancel Query icon.

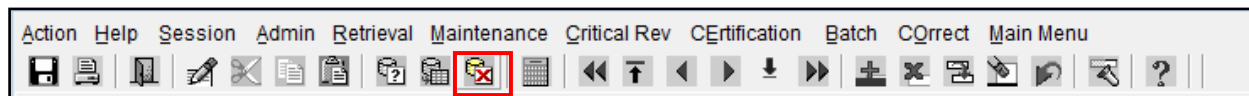

The user then needs to fill in all of the required fields. Required fields are indicated by the bolding of the field name.

The screenshot shows a software window titled "Maintain Site Samplers (National Air Data Group)". It contains two main sections: "Site Sampler" and "Sampler Channels".

Site Sampler Section:

- Sampler Owner Agency:** A text input field.
- State Code:** A text input field.
- County Code:** A text input field.
- Site Number:** A text input field.
- Sampler Id:** A text input field.
- Begin Date:** A date input field.
- End Date:** A date input field.
- Number of Channels:** A text input field.
- Manufacturer:** A text input field.
- Model Number:** A text input field.
- Serial Number:** A text input field.

Sampler Channels Section:

Channel Number	Filter Type	Target Flow Rate	Flow Unit	Begin Date	End Date

Once all of the required fields are populated the user should click the Save icon.



The status bar (at the bottom left of the screen) should indicate that a record has been applied and saved.

Tangent Roads

This is found under the Maintain section on the Menu Bar then select Site then the Tangent Roads tab. The Maintain Site Tangent Roads tab allows the user to insert or update production tangent road data associated with the Site record that was selected in the Maintain Basic Site Data window. All existing Tangent Road records are displayed when the window is opened. To display a specific tangent road or group of tangent roads associated with the current site, the user should click the Enter Query icon and enter the criteria. Clicking the Execute Query icon will display the selected Tangent Road records. The user should use the Previous Record (Left Arrow)

icon and the Next Record (Down arrow) icon to scroll through the records that have been queried. Tangent Road data can be inserted or updated in this module. Tangent Road data is deleted through batch submittal.

Open Paths

This is found under the Maintain section on the Menu Bar then select Site then the Open Paths tab. The Maintain Site Open Paths tab allows the user to insert or update production open path data associated with the Site record that has been selected in the Maintain Basic Site Data window. All existing Open Path records are displayed when the window is opened. To display a specific open path or group of open path records associated with the current site the user should click press the Enter Query icon and enter the selection criteria. Clicking the Execute Query icon will display the specific Open Path records. The user should use the Previous Record (Left Arrow) icon and the Next Record (Down arrow) icon to scroll through the records that have been queried. Open Path data can be inserted or updated in this module. Open Path data is deleted through batch submittal.

Adding Events via Maintain

Maintain Event

This section will describe how to use the maintain forms to create a new exceptional event and associate it with raw data. This section of the document is separate from the Maintain section because it is a special case - there are currently no AQS transactions for events, so the only way to enter this data is via the maintain forms.

Exceptional Event Rule

The Exceptional Event Rule (EER) was published March 22, 2007 and became effective May 21, 2007. The EER allows the ambient air quality data which is submitted to AQS and used in making regulatory decisions, to be, in some cases, flagged and, where appropriate, excluded from calculations in determining whether or not an area has attained the standard. The data flagged as “exceptional” must have been affected by an exceptional event, which is defined as an event that affects air quality, is not reasonably controllable or preventable, is an event caused by human activity that is unlikely to recur at a particular location or a natural event, and is determined by the EPA in accordance with 40CFR 50.14 to be an exceptional event.

Event Process Workflow

This section outlines exceptional event related steps occur and in what order. Not all of these steps involve AQS. Steps that are performed within AQS are in italics. How to use AQS to perform these functions is covered next.

1. Event happens. The real-world exceptional event occurs.
2. Event affects data. Ambient air quality is affected by the exceptional event and measured by monitor reporting to AQS.
3. Should data be excluded? Reporting agency investigates and determines that there is cause to suspect exceptional event influence on the sample measurement(s)
4. Data is flagged. Reporting agency adds a Request Exclusion qualifier to the affected sample measurements in AQS to flag the data in AQS as suspected of being influenced by the exceptional event (note: the flagging of data can occur either before or after the data is submitted to AQS; reporting agency has until July 1st of the year following the year in which the flagged measurement occurred to add an exceptional event qualifier flag)
5. Event is defined. Reporting agency enters the initial Event description; AQS responds by creating the event record (note: reporting agency has until July 1st of the year following the year in which the flagged measurement occurred to add an initial description of the exceptional event)
6. Associate data with event. Reporting agency accesses AQS to associate the appropriate flagged values with the Event (AQS saves date of association;
7. Justify exclusion request. Reporting agency can take up to 3 years from the time of the event to conduct analysis, hold public review, prepare justification documentation and submit documentation to the EPA. For appropriate flagged measurements, the reporting agency develops documentation that the exceedance was caused by the exceptional event.
 - a. A clear causal relationship exists between the event and the measurement;
 - b. The measurement is in excess of normal historical fluctuations, including background;
 - c. There would not have been an exceedance or violation if the event had not occurred;
 - d. The required public comment process has been followed;
 - e. The documentation package includes references to specific exceedances of a specific NAAQS.
8. Submit package. Reporting agency submits (via hardcopy or electronic means) the required justification documentation for affected measurements to their EPA Regional Office
9. Regional Review. EPA Regional Administrator reviews documentation with respect to:

- a. Validity of event occurrence;
 - b. Causal relationship to the monitoring data (exceedances) under consideration
10. EPA Concurrence Indicator Updated. Regional administrator accesses AQS to Concur or Deny with the exclusion request, with respect to the specific NAAQS
 11. Exclude Data. AQS re-computes affected summaries.

Flag Values with Event Qualifiers

Sample values (raw data) can be flagged using either the Batch process or Maintain forms.

EDT ID

An identification code indicating the Exceptional Data Type or Event Qualifier Code type for a raw or composite data point. "Concurrence" is a flag set by the EPA Region indicating agreement with the Exceptional Data qualifier. EDTs are represented with a numeric value.

Event Qualifiers

The qualifiers are currently broken into 4 different types:

1. Quality Assurance

QA qualifiers are indicators of data validation. The "V" qualifier to indicate validated data is used on all parameters. The other QA qualifiers are normally only used for PM2.5.

These qualifiers are used to indicate that while the indicated QA procedure may have cast doubts on the validity of the data, upon review it is considered valid. Raw data records for invalid data are entered with no data value. Such null data entries should be qualified with a null value code (see below).

2. Exceptional Events

"An exceptional event is defined as an event that is not expected to recur routinely at a given location, or that is possibly uncontrollable or unrealistic to control through the SIP process... What is exceptional in one area of the country may not be exceptional in another." (EPA Guideline on the Identification and Use of Air Quality Data Affected by Exceptional Events, OAQPS, EPA-450/4-86-007, July 1986)

In the AQS systems, exceptional events are considered to be "anthropogenic". All other causes are considered to be "Natural events" described below. AQS makes no finer distinction between intentional and unintentional exceptional events other than to describe the event itself.

3. Natural Events

Natural events that can influence raw data values include Metrological events such as high winds, inversions, intrusions or drought. Geological events such as volcanoes are included along with some seasonal events such as Forest fires and High pollen count.

Note that "Prescribed burning" is an Intentional Anthropogenic Event while "Forest fires" are considered Natural Events.

4. Null Data Values

Null Data Values explain the cause of null values that occur for reasons other than levels being below a device's minimum detection limit. These include power failures, equipment damage and human error. Note that there is a difference between NULL and ZERO in the database. Zero is a reported value indicating undetectable pollutant levels for the device. Null indicates a missing, invalid or unknown value.

5. Comments

Comments can be attached to any Qualifier code to further describe an event, if necessary. This ability to attach comments applies to all qualifiers.

Note] for further guidance refer to:

- 40 CFR, part 50, Appendix K
- Section 188(f) of the 1990 Clean Air Act Amendments which modify some of the Appendix K based guidelines of 1986.
- MEMORANDUM: Areas Affected by PM-10 Natural Events, FROM: Mary Nichols, Assistant Administrator for Air and Radiation. This memorandum clarifies apparent conflicts between Appendix K, the Exceptional Events Guideline from 1986 and Section 188(f)

Flagging Values via Batch Data

6. Create transactions that have Request Exclusion Qualifiers (see the Data Coding Manual for details) appropriate to the event type.
 - a. The transactions can be Insert transactions for new data or Update or Replace transactions for data already in AQS.
7. Load this data using the Batch process.

Flagging Values via Maintain

1. The reporting agency user determines that a specific sample measurement (or small set of measurements) is affected by an exceptional event.
2. The user decides whether to flag the sample measurement with the Informational Qualifier (“INFORM”) or the Request Exclusion Qualifier (“REQEXC”) for the event.
3. The user queries the measurement. In AQS, Maintain → Sample Values → Raw Data

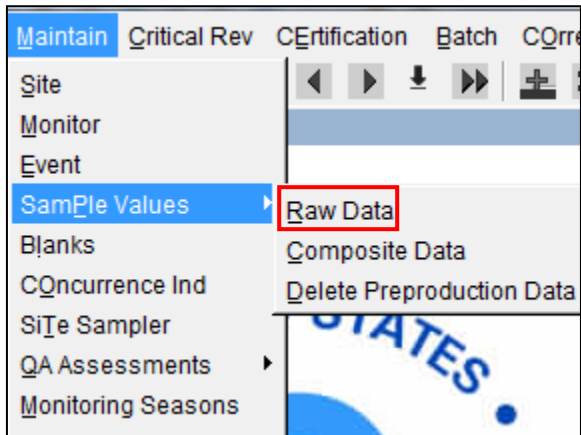

- The user will then use the Query tool to select the sample measurement to which the user wants to add (or modify) the qualifier code. (State, County, Site, Parameter and/or Begin and End Dates. Then Execute Query)

Maintain - Raw Data (National Air Data Group)

Raw Data | Comments

State: 37 | County: 063 | Site: 9999 | Parameter: 88101 | POC: 1 | Begin Date: | End Date: | Standard Units: 105

Raw Data Mp ID	Date	Time	Stat Ind	Reported Sample Value	Standard Sample Value	EPA Ind	Action Ind	Exclusion Ind	Null Data Code	Description	Uncertainty Value
1	20140220	00:00	P	2	2						
1	20140214	00:00	P	3	3						
1	20140208	00:00	P	1	1						

Qualifier Code: | Qualifier Desc: | Qualifier Type: | Association Date: |

Event Description: |

Event Comment: |

Event URL: |

Monitor Protocol: | Method: 116 | Unit: 105 | Duration: 7 | Coll Frequency: | Alt Mdl: |

- The user will then add an exceptional event qualifier to the raw data record.
The user will select the record to add the exceptional event to by clicking the record field, the respective record should now be highlighted.

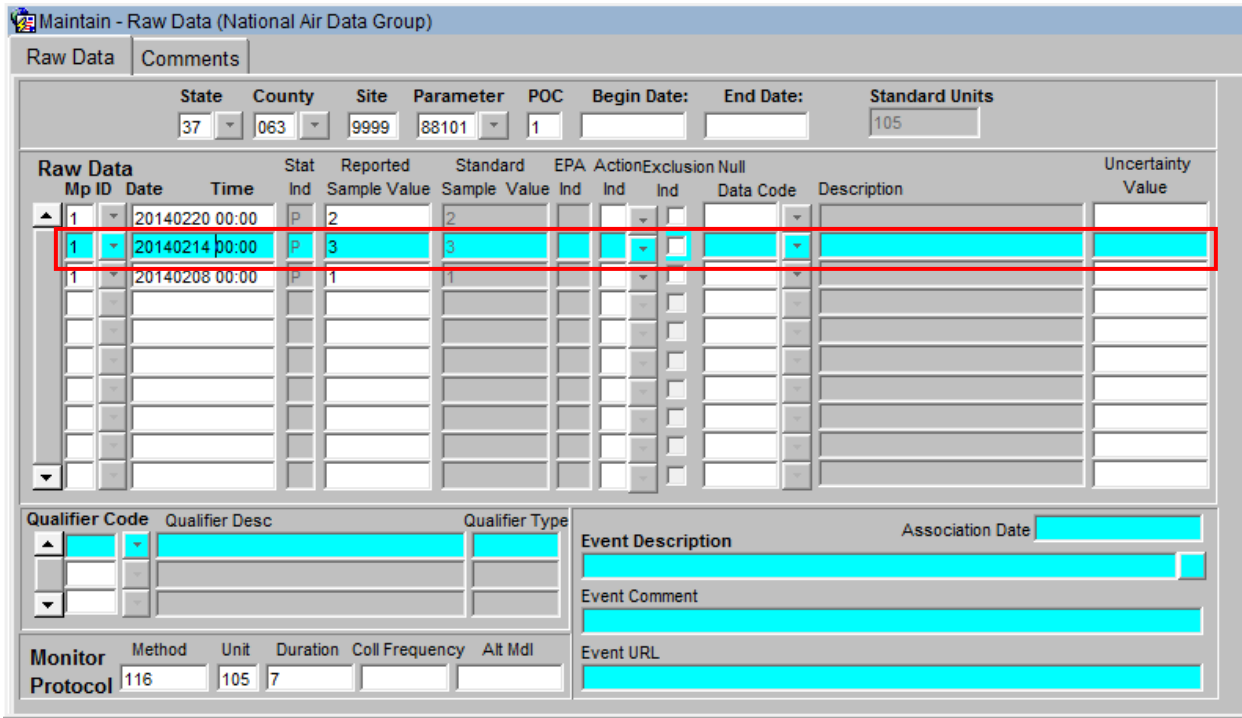

At this point the user will select the appropriate code from the (1) Qualifier Code drop down menu. This will open a (2) pop-up, for the user to select the exceptional event.

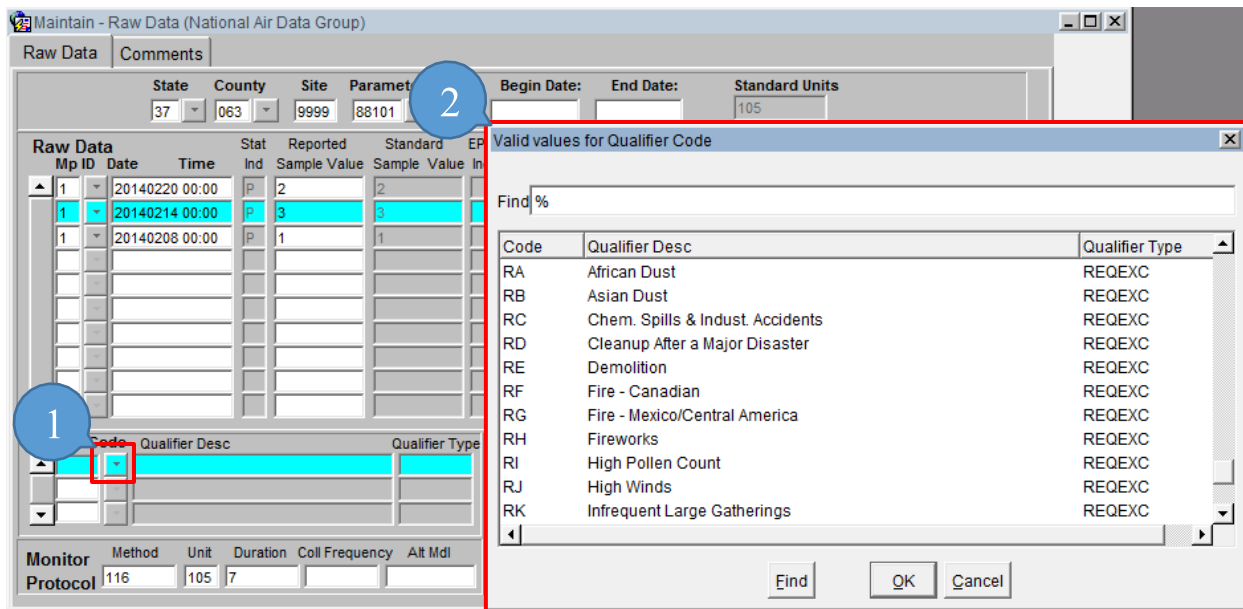

Note] Exclusion Qualifier (“REQEXC”) codes all begin with the letter ‘R’.

Then, the user will save the changes by clicking the Save icon.

The sample value now has an exceptional event qualifier. Before this sample is visible to the Regional Office for concurrence purposes, the sample values must be associated with an Exceptional Event. (See the next section.)

Defining an Exceptional Event

Exceptional events must be described and documented in order for EPA regional office to concur on affected data requests. This documentation must be completed in AQS via online forms.

Users do not have to define an exceptional event as a prerequisite to flagging measurement data with the qualifier code. However, if a user requests concurrence from EPA for flagged data to be excluded, then the exceptional event needs to be defined before the concurrence flags can be set.

In order to add exceptional events the user must be in the screening group that “owns” the data and the user must have the authority to edit raw data and event data.

The event can be defined either via Maintain Exceptional Events (recommended if it is anticipated that this event will affect many sample values) or via Maintain Raw for each sample value.

Using Maintain Event to Define and Associate Events

The user will click Maintain on the Menu Bar. This will open the drop down and the user will then select Event. This will open up the Maintain Exceptional Events form.

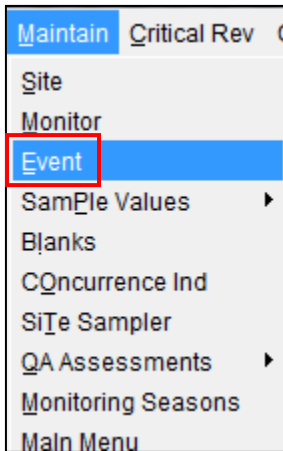

Required information to define an exceptional event:

- Qualifier Code (this is the type of event and are selected from the drop down - these map to the REQEXC type qualifiers).
- Event Description.

Optional information:

- Event Begin Date.
- Event End Date.
- Comment.
- URL.

On the Define Event tab the user will:

1. Use the drop down on “Qualifier Code” to select the type of exceptional event - **required**
 - a. The “Qualifier Description” field will be populated with the description matching the Qualifier Code selection.
2. Add an “Event Begin Date” and “Event End Date” in YYYYMMDD format – **optional**
 - a. Usually exceptional events have a distinct begin and end date.
3. “Event Description” – comment field - **required**
4. “Comment” – comment field - **optional**
5. “URL” – add a link to a webpage to add additional explanatory materials - **optional**

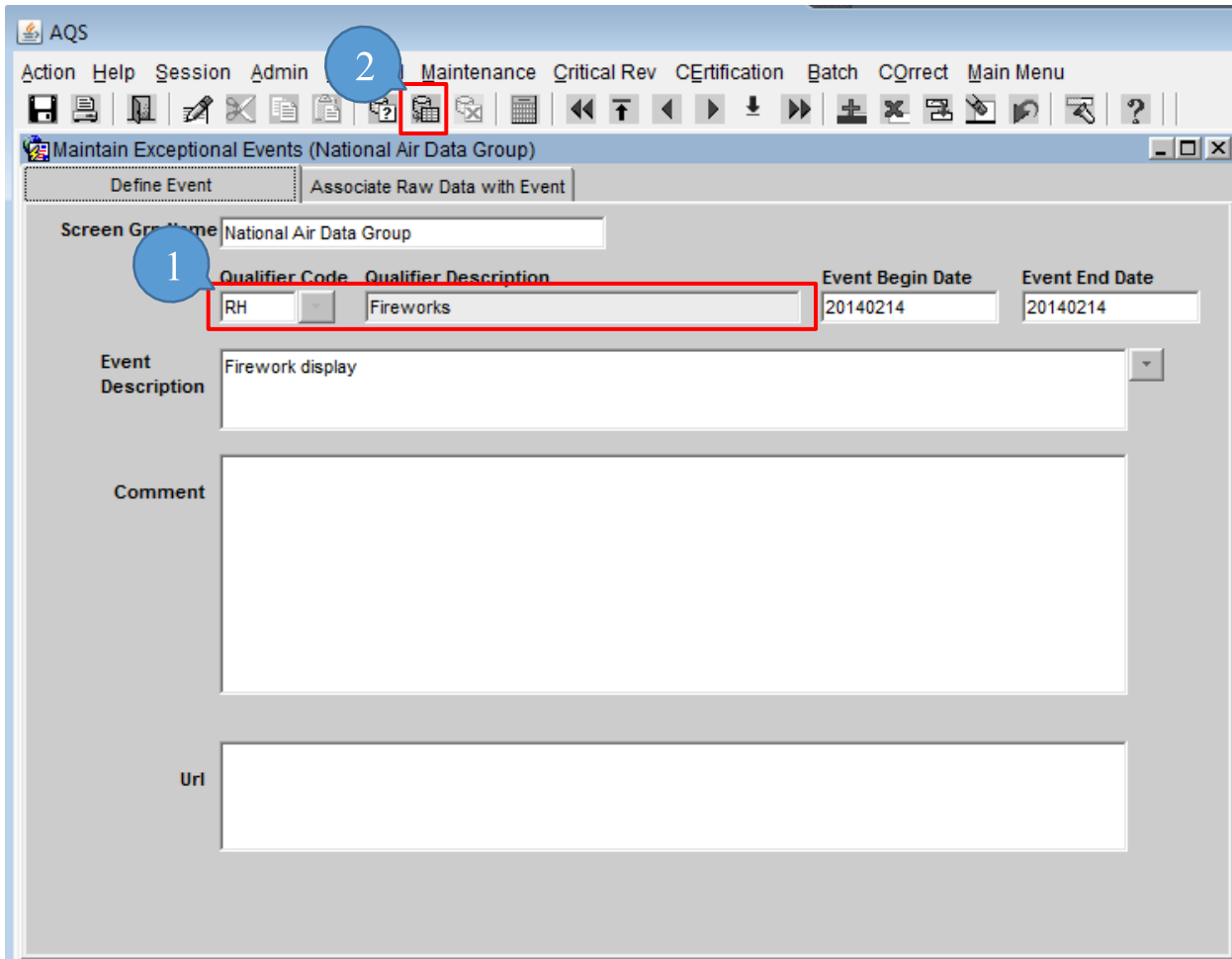

If there is an existing Exceptional Event, then the user can query the event by:

1. Entering the qualifier code and/or the event description.
2. Submitting the query using the “Execute Query” icon.

The events that match the query criteria will display on the Define Event tab.

[Interactive Training – Define an Exceptional Event](#)

Associate Raw Data with Event

To associated raw data with an event the user will select the Associate Raw Data with Event tab.

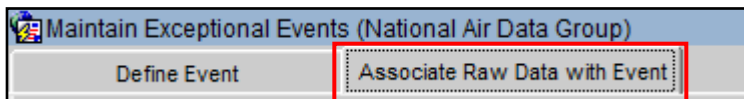

To see which monitors are associated with this event, or to associate a monitor with this event, the user will select “Query Affected Monitors.”

Maintain Exceptional Events (National Air Data Group)

Define Event Associate Raw Data with Event

Event Description
Firework display

Screen Grp Name Qualifier Code Qualifier Description Event Begin Date Event End Date
National Air Data Group RH Fireworks 20140214 20140214

State Code County Code Site ID Parameter POC

Query Affected Monitors

Query By Date Range Associate All Disassociate All Reset Actions

Monitor Key	Begin Date	End Date	# Associated	# Unassociated	Action

In order for the user to associate any unassociated monitors with the event, the Action LOV button must be clicked for the respective row.

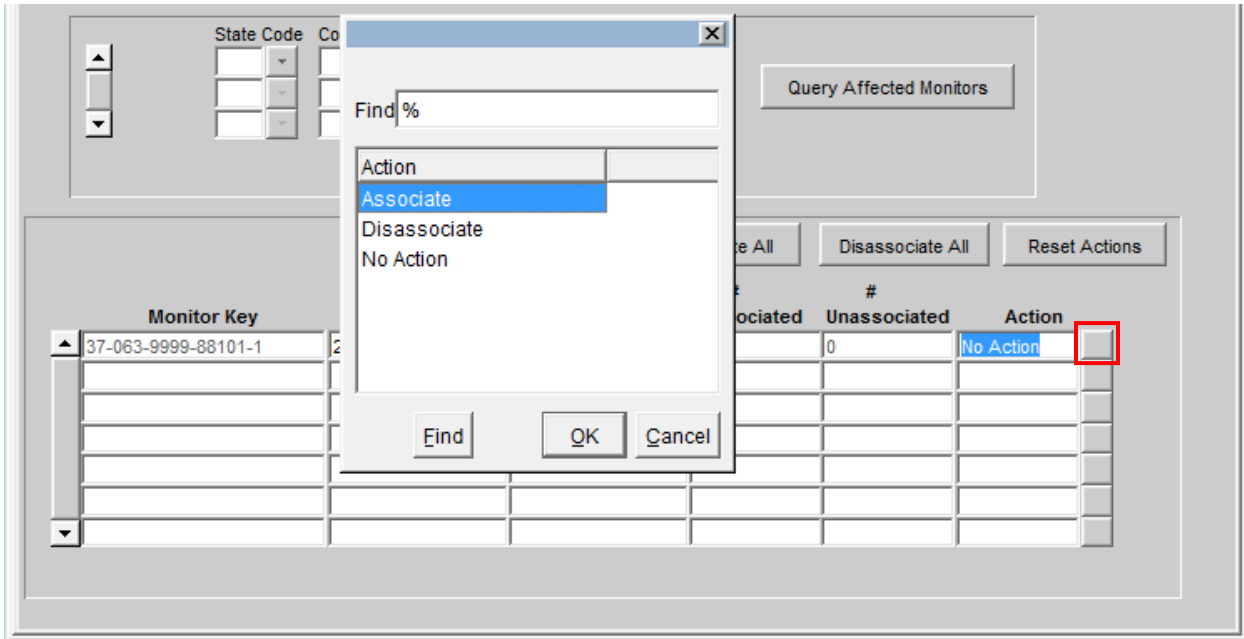

This will open a pop-up that allows the user to select 'Associate' to associate the affected monitor/s. Then the user will click 'OK'.

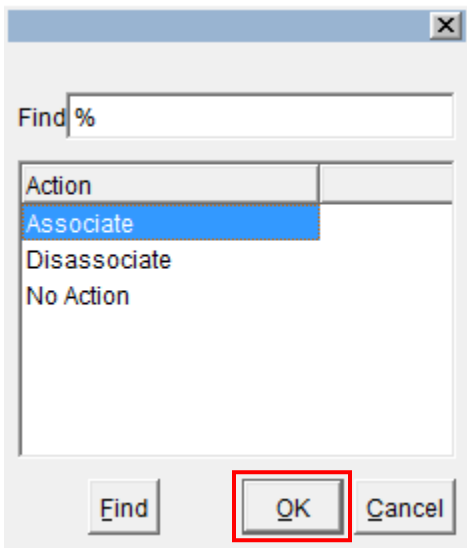

At this point the user will notice that the monitor will now display in the '# Associated' column.

Monitor Key	Begin Date	End Date	# Associated	# Unassociated	Action
37-063-9999-88101-1	20140214	20140214	1	0	Associate

Once the user verifies that all information is correct the 'Save' icon should be clicked.

The sample measurements that match these criteria and that were flagged with the qualifier flag are now available for the Regional Office to set the concurrence indicators via the Maintain Concurrence menu in AQS.

Query by Date

The user can also query the events by date. After the monitor data has been retrieved by the 'Query Affected Monitors' button, the user can change the Begin Date and/or End Date values. Then click the 'Query By Date Range' button. The flagged data available will be limited to that which falls between these new dates.

<input type="button" value="Query By Date Range"/>						<input type="button" value="Associate All"/>	<input type="button" value="Disassociate All"/>	<input type="button" value="Reset Actions"/>
Monitor Key	Begin Date	End Date	# Associated	# Unassociated	Action			
37-063-9999-88101-1	20140214	20140214	1	0	Associate			

Add concurrence flag Regional Administrator

The Regional Administrator role has the ability to update the EPA_Concurrence_Ind field on the RAW_DATA table for any state within their region. Their designated region is specified on the AIRS_USER_PROFILE table. The Regional Administrator also has sole update privilege for the Regional Evaluation Date on the Site record.

Regional Office

An EPA Regional Office AQS user can add a concurrence flag to signify that they concur with the exclusion of sample measurements due to an exceptional event. This concurrence can only be done via online forms.

A “Concur” flag means that the Regional Office concurs with the exclusion. A “Deny” means that the Regional Office does not concur with the exclusion.

Certification is preserved when data is Concurred or Non-Concurred. The Certification of a Monitor-Year is only removed when the concentration value of a sample measurement is updated, but not when other fields are updated.

Sample values can be concurred/non-concurred based on different existing standards:

Pollutant	Standards
O ₃	8-hour 2008 1-hour Daily 2005 8-hour 1997
SO ₂	24-hour 1971 3-hour 1971 Annual 1971
NO ₂	Annual 1971
CO	8-hour 1971 1-hour 1971
Pb	Quarterly 1978
PM ₁₀	24-hour 2006
PM _{2.5}	24-hour 2006 Annual 2006

Work Flow

1. The Regional Office user evaluates the documentation for a sample measurement that was flagged as being affected by an exceptional event.
2. The Regional Office user will use the Maintain Concurrence form in AQS to query the affected sample measurements and to set the concurrence flag. To access this portion of AQS, the user must have the correct authorization. An authorized Regional Office user would have access to all the monitors in that region. From the Menu Bar, the user will click 'Maintain' then select 'Concurrence Ind'.

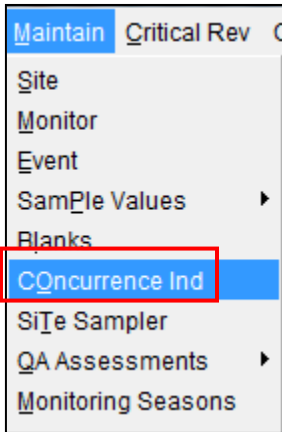

3. Query the affected sample measurements:

Action Help Session Admin Retrieval Maintain Critical Rev Certification Batch Correct Main Menu

Maintain - EPA Concurrence Indicator (Region 4 Atlanta)

State: 37 County: 063 Site: 9999 Parameter: 88101 POC: 1

Begin Date: End Date: Applicable NAAQS Standard:

Screening Group Name: Event Type: Event Description:

Concur All Deny All Clear All

Concur Ind	Monitor	Samp Begin Date-time	Std Samp Value	Std Unit	Qualifier Code	Qualifier Description	Applicable NAAQS Standard
▲	37-063-9999-88101-1	20140214 00:00	3	105	RH	Fireworks	PM25 24-hour 2006
▼	37-063-9999-88101-1	20140214 00:00	3	105	RH	Fireworks	PM25 Annual 2006
▼	37-063-9999-88101-1	20140214 00:00	3	105	RH	Fireworks	PM25 24-hour 2013
▼	37-063-9999-88101-1	20140214 00:00	3	105	RH	Fireworks	PM25 Annual 2013
▼							
▼							
▼							
▼							
▼							
▼							

Event Description: Firework display

Event Comment:

Event Uri:

Concurrence Comment:

Concurrence Date:

Open URL

4. Where applicable, the concurrence flag can be set for a particular standard.

Maintain - EPA Concurrence Indicator (Region 4 Atlanta)

State: 37 County: 063 Site: 9999 Parameter: 88101 POC: 1

Screening Group Name: Event Type: Event Description:

Concur All Deny All Clear All

Concur Ind	Monitor	Samp Begin Date-time	Std Samp Value	Std Unit	Qualifier Code	Qualifier Description	Applicable NAAQS Standard
	37-063-9999-88101-1	20140214 00:00	3	105	RH	Fireworks	PM25 24-hour 2006
	37-063-9999-88101-1	20140214 00:00	3	105	RH	Fireworks	PM25 Annual 2006
	37-063-9999-88101-1	20140214 00:00	3	105	RH	Fireworks	PM25 24-hour 2013
	37-063-9999-88101-1	20140214 00:00	3	105	RH	Fireworks	PM25 Annual 2013

Event Description: Firework display
 Event Comment:
 Event Url: Open URL

Concurrence Comment:
 Concurrence Date:

5. If the region agrees with the exclusion they will enter 'Y' in the 'Concur Ind' field.

Concur Ind	Monitor
Y	37-063-99
	37-063-99

Note] a "Concur" flag means that the Regional Office concurs with the exclusion. A "Deny" means that the Regional Office does not concur with the exclusion.

6. The Regional Office will save the changes using the “Save” icon.

The addition of an exceptional event qualifier flag to sample values initiates (during the POST process) the re-computation of all of the summaries:

- At monitor-level:
 - NAAQS Averages
 - Daily Summaries
 - Quarterly Summaries
 - Annual Summaries
- At site-level:
 - Daily Summaries
 - Quarterly Summaries
 - Annual Summaries

Maintain Cylinder

Protocol Gas Cylinder

PGVP Id 2

1 Cylinder Id

Owning Agency

Certification Date Expiration Date 3
(YYYYMMDD) (YYYYMMDD)

Comments

Parameter Code	Unit Code	Certified Concentration
<input type="text"/>	<input type="text"/>	<input type="text"/>
<input type="text"/>	<input type="text"/>	<input type="text"/>
<input type="text"/>	<input type="text"/>	<input type="text"/>
<input type="text"/>	<input type="text"/>	<input type="text"/>

This is found under the Maintain section on the Menu Bar then select Cylinder. It provides the ability to directly view, enter or edit cylinder data in the database for the selected screening group. This form is optional by SLTs, but EPA highly encourages usage as soon as possible. Monitoring programs that use this form are considered by OAQPS as meeting their annual EPA Protocol Gas reporting requirements and no longer need to participate in the annual AA-PGVP survey. This form documents the EPA Protocol Gas Cylinder Standards used in the NAAQS monitoring networks.

- (4) Producer ID [also known as Protocol Gas Verification Program ID (PGVP ID)] is validated against EPA approved Specialty Gas Producers and Certifiers of EPA Protocol Gas Standards. Valid producer IDs are managed internally by OAQPS through the Maintain Cylinder form.
- (5) Serial number of the cylinder assigned by the manufacturer
- (6) Certification Date is the date the cylinder is certified by its manufacturer to contain the specified concentration of the gas identified by the Parameter Code. The Expiration Date is date after which the cylinder gas concentration is no longer certified to by within the tolerance limits of the cylinder certified concentration

Maintain – 1-Point QC

The Maintain -> QA Assessments -> 1-Point QC form is used to enter or edit all 1-point quality control check data for a monitor.

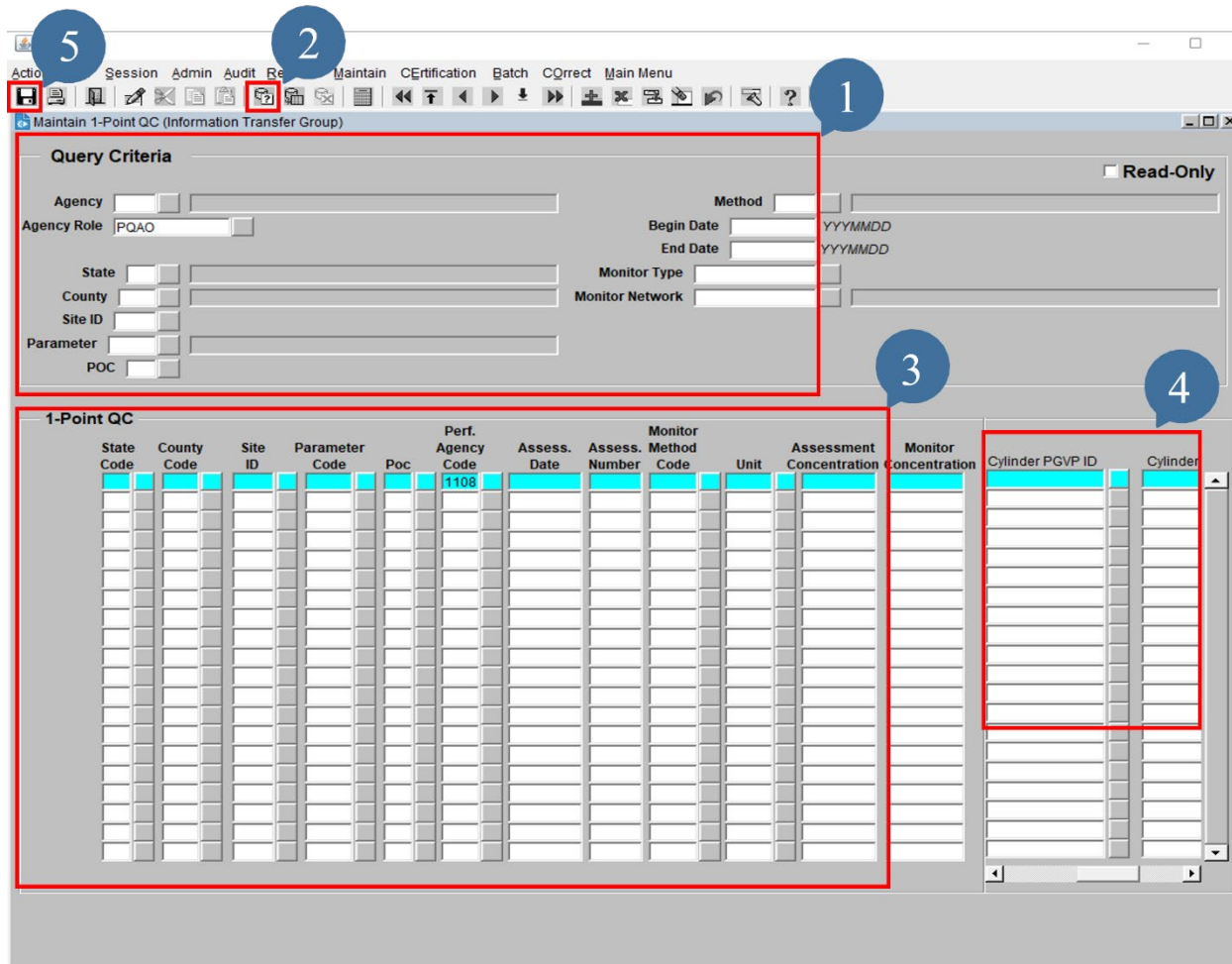

1. The User fill out the values that will be used to query records
2. Execute the query using the parameters filled out above
3. Query results will be returned here. The user may add, delete or edit records here.
4. New: Producer ID and Cylinder ID are now displayed where present in the database. The Producer ID is a unique identifier of the organization that produced the cylinder being assessed. The Cylinder ID is the unique identifier (e.g. serial number) of the gas cylinder being assessed.
5. Click the Save icon

Maintain – QA Annual Performance Evaluation

The Maintain -> QA Assessments -> Annual Performance Evaluation form is used to enter or edit all annual performance data for a monitor.

- (1) On this form, users may query annual performance evaluations for a monitor during a specified date range.
- (2) All Annual Performance Evaluations for the queried fields. Users can edit or add performance evaluation data in this section. Individual evaluations are displayed on each line.
- (3) New: Cylinder PGVP ID and Cylinder ID are now present when provided. The Cylinder PGVP ID is a unique identifier of the organization that produced the cylinder being assessed. The Cylinder ID is the unique identifier (e.g. serial number) of the gas cylinder being assessed.

Setting up and mapping monitors to samplers and sampler channels

This walk thru will explain how a user can create and load the necessary transaction to associate speciation samplers with monitors so that flow quality assurance data can be submitted.

A sampler is the physical piece of equipment.

This is the top of a sampler with 8 channels, 3 of which are being used.



Here the sampler cover is down and the filters can be seen in three of the channels.



In AQS, a monitor is defined as a parameter measured at a site. Thus each filter will be associated with a monitor for each parameter that the filter is analyzed for (typically between 3 and 60 parameters for each filter).

Note] this tutorial assumes that the user has already setup the samplers and sampler channels.

The user should verify the samplers and sampler channels are setup. To do this the user will open the Maintain Site Samplers form. After logging in to AQS the user will select Maintain from the Menu Bar then select Site Sampler from the drop down menu. This will open a blank Maintain Site Samplers form.

Maintain Site Samplers (National Air Data Group)

Site Sampler

Sampler Owner Agency

State Code

County Code Site Number

Sampler Id

Begin Date End Date Number of Channels

Manufacturer

Model Number

Serial Number

Sampler Channels

Channel Number	Filter Type	Target Flow Rate	Flow Unit	Begin Date	End Date

Here the user should fill in the relative information.

Site Sampler

Sampler Owner Agency

State Code

County Code Site Number

Sampler Id

Begin Date End Date Number of Channels

Manufacturer

Model Number

Serial Number

Then the user will click the Execute Query icon. This will populate the form and allow the user to verify Samplers and Sampler Channels.

Site Sampler

Sampler Owner Agency: 0776 North Carolina Dept Of Environment And Natural Resources 37-035-0004

State Code: 37 North Carolina

County Code: 035 Catawba Site Number: 0004

Sampler Id: MET-ONE-A

Begin Date: 20020101 End Date: Number of Channels: 4

Manufacturer: Met One Instruments
Model Number: SASS
Serial Number:

Sampler Channels

Channel Number	Filter Type	Target Flow Rate	Flow Unit	Begin Date	End Date
1	TEFLON	6.7	118	20020101	
2	NYLON	6.7	118	20020101	
3	QUARTZ	6.7	118	20020101	

If there are multiple samplers the user can click the Next Record icon to move to the next sampler.

In order to set up and map monitors to samplers and sampler channels the user will create a text document containing AQS Monitor Channel (MP) transactions. Each transaction should contain:

1. Transaction Type, which will be MP, for monitor channel
2. Action Code, which will be I, for insert
3. State Code
4. County Code
5. Site ID
6. Parameter
7. POC
8. Sampler ID
9. Channel Number
10. Begin Date, this is the begin date for the affiliation of the monitor to the sampler.

MP	I	01	073	0023	88104	5	MET-ONE-A	1	20010101
MP	I	01	073	0023	88107	5	MET-ONE-A	1	20010101
MP	I	01	073	0023	88109	5	MET-ONE-A	1	20010101
MP	I	01	073	0023	88110	5	MET-ONE-A	1	20010101
MP	I	01	073	0023	88111	5	MET-ONE-A	1	20010101
MP	I	01	073	0023	88112	5	MET-ONE-A	1	20010101
MP	I	01	073	0023	88113	5	MET-ONE-A	1	20010101
MP	I	01	073	0023	88114	5	MET-ONE-A	1	20010101
MP	I	01	073	0023	88115	5	MET-ONE-A	1	20010101
MP	I	01	073	0023	88117	5	MET-ONE-A	1	20010101
MP	I	01	073	0023	88118	5	MET-ONE-A	1	20010101
MP	I	01	073	0023	88126	5	MET-ONE-A	1	20010101
MP	I	01	073	0023	88128	5	MET-ONE-A	1	20010101
MP	I	01	073	0023	88131	5	MET-ONE-A	1	20010101
MP	I	01	073	0023	88132	5	MET-ONE-A	1	20010101
MP	I	01	073	0023	88136	5	MET-ONE-A	1	20010101

The user may also run a report that will list transaction for all samplers, sampler channels, and parameters associated with his site to assist in the creation of the text file.

The user will select Retrieval from the Menu Bar then select Standard Report Selection from the drop down menu. This will open the Standard Report Criteria Selection form. In the Report Code field the user will use the drop down to select the Extract Site/Monitor Data Report (AMP 500).

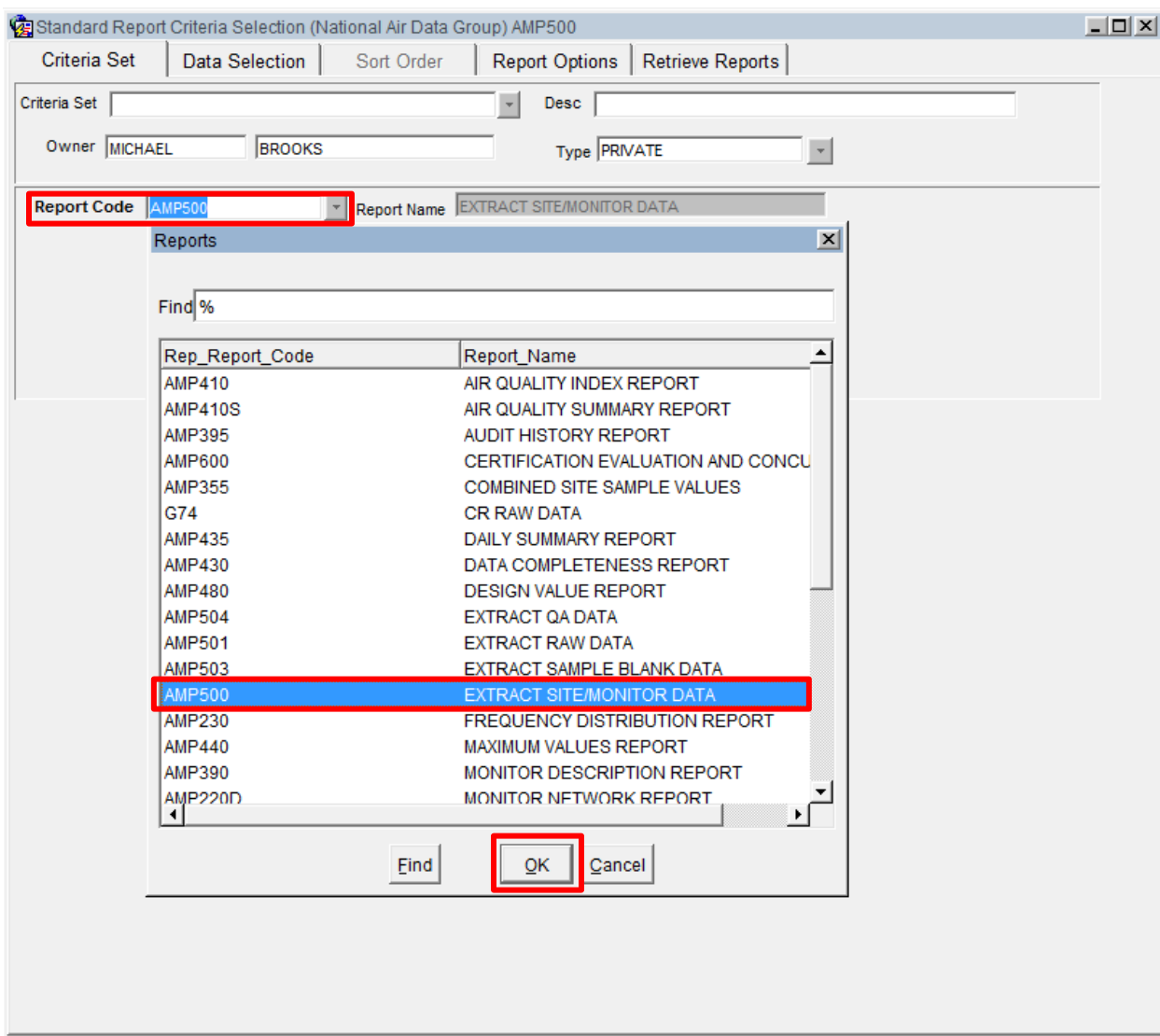

After this selection is made the user will click the Data Selection tab. The user will then fill in all the relative fields. In Protocol Criteria area of the form the user will choose ALL for pollutant type.

Standard Report Criteria Selection (National Air Data Group) AMP500

Criteria Set **Data Selection** Sort Order Report Options Retrieve Reports

Monitor / Geographic Criteria

State Code	County Code	Site Id	Parameter Code	POC	City Code	AQCR Code	UAR Code	CBSA Code	CSA Code	EPA Region Code
01	073	0023		5						

Protocol Criteria

Pollutant Type	Parameter Code
ALL	

Date Criteria

▲
▼

Screening Group

_____ ▼

Monitor Network

▲

▼

Monitor Type

▲

▼

Generate Report

The user will then click on the Report Options tab. Then click the Uncheck All button on the form.

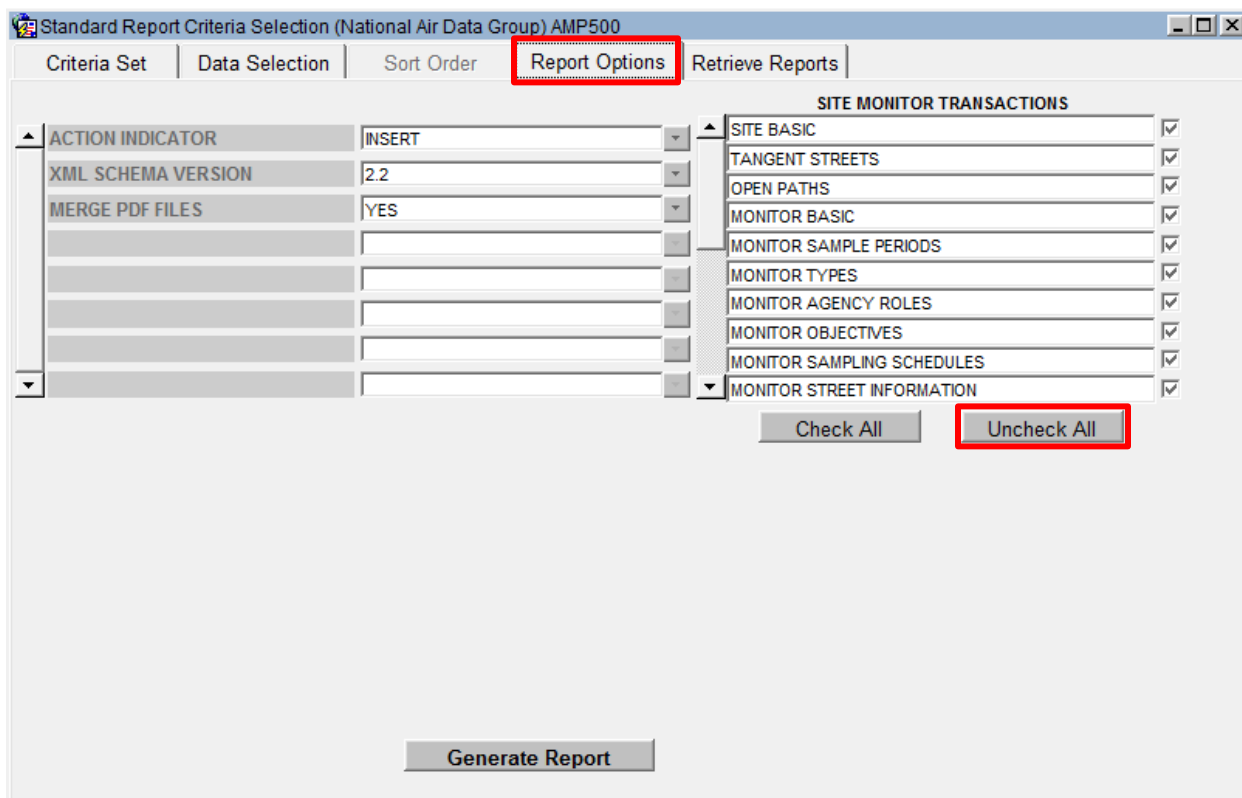

The user will then select MONITOR BASIC by clicking the check box to the right of the selection.

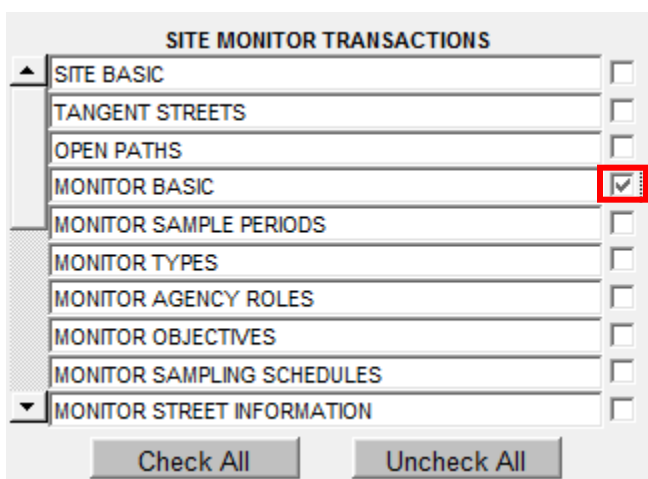

The user will then scroll down and select SITE SAMPLERS and SAMPLER CHANNELS.

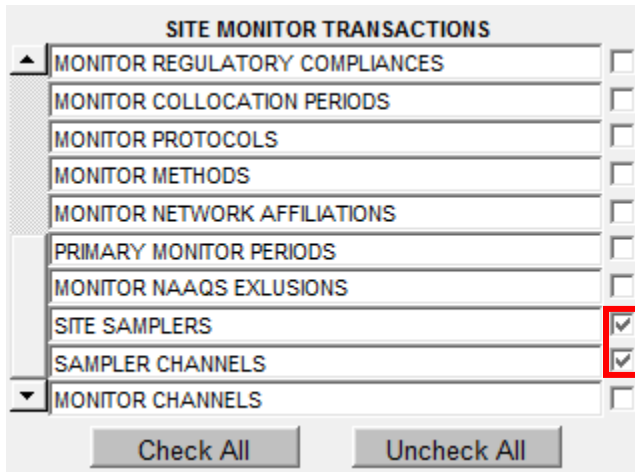

The user will then click the Generate Report button. The user may use this information in creating the text file needed to create and map the monitors to the appropriate samplers and sampler channels.

```

AMP500_1492623-0.txt - Notepad
File Edit Format View Help
# AD|Action Code|State Code|County Code|Site Number|Sampler ID|Sampler Owner|Manufacturer|Model Number
# AE|Action Code|State Code|County Code|Site ID|Sampler ID|Channel Number|Filter Type|Target Flow Rate
# MA|Action Code|State Code|County Code|Site ID|Parameter|POC|Project Class|Dominant Source|Measurement
AD I 01 073 0023 MET-ONE-A 0013 Met One Instruments SASS 4 20010101
AD I 01 073 0023 URG-A 0013 URG 3000N 1 20070503
AE I 01 073 0023 MET-ONE-A 1 TEFLON 6.7 118 20010101
AE I 01 073 0023 MET-ONE-A 2 NYLON 6.7 118 20010101
AE I 01 073 0023 MET-ONE-A 3 QUARTZ 6.7 118 20010101
AE I 01 073 0023 URG-A 1 QUARTZ 22 118 20070503
MA I 01 073 0023 68101 5
MA I 01 073 0023 68102 5
MA I 01 073 0023 68103 5
MA I 01 073 0023 68104 5
MA I 01 073 0023 68105 5
MA I 01 073 0023 68106 5
MA I 01 073 0023 68107 5
MA I 01 073 0023 68108 5
MA I 01 073 0023 81102 5 05 AREA NEIGHBORHOOD TOP OF BUILDING 4 1 1 1 1 1 1 1 0199 1 1 1 1
MA I 01 073 0023 86101 5
MA I 01 073 0023 88102 5
MA I 01 073 0023 88103 5
MA I 01 073 0023 88104 5
MA I 01 073 0023 88107 5
MA I 01 073 0023 88109 5
MA I 01 073 0023 88110 5
MA I 01 073 0023 88111 5
MA I 01 073 0023 88112 5
MA I 01 073 0023 88113 5
MA I 01 073 0023 88114 5
MA I 01 073 0023 88115 5
MA I 01 073 0023 88117 5
MA I 01 073 0023 88118 5
  
```

Here the user can see the three selections that were made:

1. AD is Site Sampler
2. AE is Sampler Channel
3. MA is Monitor Basic

```
AMP500_1492623-0.txt - Notepad
File Edit Format View Help
# AD|Action Code|State Code|County Code|Site Number|Sampler I
# AE|Action Code|State Code|County Code|Site ID|Sampler ID|Ch
# MA|Action Code|State Code|County Code|Site ID|Parameter|POC
AD|I|01|073|0023|MET ONE 4|0013|Met One Instruments|5455|1412
```

And all of the Parameters associated with the site.

```
MA|I|01|073|0023|88102|5|
MA|I|01|073|0023|88103|5|
MA|I|01|073|0023|88104|5|
MA|I|01|073|0023|88107|5|
MA|I|01|073|0023|88109|5|
MA|I|01|073|0023|88110|5|
MA|I|01|073|0023|88111|5|
MA|I|01|073|0023|88112|5|
MA|I|01|073|0023|88113|5|
MA|I|01|073|0023|88114|5|
MA|I|01|073|0023|88115|5|
MA|I|01|073|0023|88117|5|
MA|I|01|073|0023|88118|5|
```

The MA transactions can be used as a template to create the MP transactions described earlier. The MA transactions will contain the monitor identifier (state + county + site + parameter + POC) for all monitors at the site. These can be edited, duplicated, etc. to create the necessary valid MP transactions.

After the user creates the text file he can then submit it through the ENSC (Exchange Network Services Center). Once the submission is complete all of the monitors should be appropriately mapped to the samplers and sampler channels.

Delete Obsolete Records

In order to delete obsolete records in AQS the user will open the Delete Obsolete Records form area. To access this form the user will click Critical Rev on the Menu Bar, which will open the drop down where the user will then select Delete Obsolete Records. This will open the Critical Review – Delete Obsolete Records form. Here the user will click the Delete Obsolete Records tab.

The data administrator will have the ability to delete records from the critical review areas. It is anticipated that this will be utilized every six months based on the "Date of Update" field. These records will be deleted from the critical review tables.

The Data Administrator can select a date range and the Critical Review Raw Data records will be deleted for all Critical Review Records within the specified range, based on the Date of Update.

To use the Delete Obsolete Function the user must enter Query Mode.

This can be done by selecting the Enter Query icon located on the menu. Selecting the Execute Query icon executes the query after entering your desired parameters. To exit Query Mode select the Cancel Query Mode icon or press Ctrl-Q on your keyboard.

Note: When in Query Mode all menu items are locked except for context sensitive help.

Data Reports

List of Standard Reports

This is a table of all standard reports.

Most reports have a minimum set of required selection criteria, without which they will not run. For Parameter, either a specific parameter number or Pollutant Type group name (such as CRITERIA or ALL) is required. For Geography, any geographical specification on the active selection tab is acceptable.

REPORT_CODE	REPORT_NAME	DATE	PARAMETER	GEO
AMP025	Screening Group Inventory			
AMP220D	MONITOR NETWORK	Y	Y	Y
AMP230	FREQUENCY DISTRIBUTION REPORT	Y	Y	Y
AMP251	QA Raw Assessment Report			
AMP256	QA Data Quality Indicator report			
AMP260	REDUCED FREQUENCY DISTR REPORT	Y	Y	Y
AMP300	VIOLATION DAY COUNT REPORT	Y	Y	Y
AMP350	RAW DATA REPORT	Y	Y	
AMP350MX	RAW DATA MAX VALUES REPORT	Y	Y	Y
AMP350NW	RAW DATA NAAQS AVERAGES	Y	Y	Y
AMP350P	RAW DATA REPORT PREPRODUCTION	Y	Y	
AMP355	Combined Site Sample Values			
AMP360	Raw Data Qualifier Report			

AMP380	SITE DESCRIPTION REPORT			Y
AMP390	MONITOR DESCRIPTION REPORT		Y	Y
AMP410	AIR QUALITY INDEX REPORT	Y		Y
AMP410S	AIR QUALITY SUMMARY REPORT	Y	Y	Y
AMP430	DATA COMPLETENESS REPORT	Y	Y	Y
AMP435	DAILY SUMMARY REPORT	Y	Y	Y
AMP440	MAXIMUM VALUES REPORT	Y	Y	Y
AMP450	QUICKLOOK CRITERIA PARAMETERS	Y	Y	Y
AMP450NC	QUICKLOOK ALL PARAMETERS	Y	Y	Y
AMP470	Raw Values by Year			
AMP480	DESIGN VALUE REPORT	Y	Y	Y
AMP500	EXTRACT SITE/MONITOR DATA		Y	Y
AMP501	EXTRACT RAW DATA	Y	Y	Y
AMP503	EXTRACT BLANKS DATA	Y	Y	Y
AMP504	Extract QA Data			
AMP600	Certification Evaluation and Concurrence			
G74	CR Raw Data			

Generating Reports

Reports are found under the Retrieval section located on the Menu Bar.

Under Retrieval there are a number of Browse reports where you can view data on the system. Browse reports are for reviewing information and are not designed for exporting or printing data.

Standard Reports Overview

In AQS, the most common way to view data is via Standard Reports. These are pre-defined reports that show most of the data in AQS.

This section gives a brief overview of how to use the reports function of AQS.

Standard Reports Form

[Interactive Training – Running a Report](#)

Criteria Set Tab

AQS Standard Reports are under Retrieval in the Menu Bar. To navigate to them, the user will click 'Retrieval' from the Menu Bar then select 'Standard Report Selection' from the drop-down.

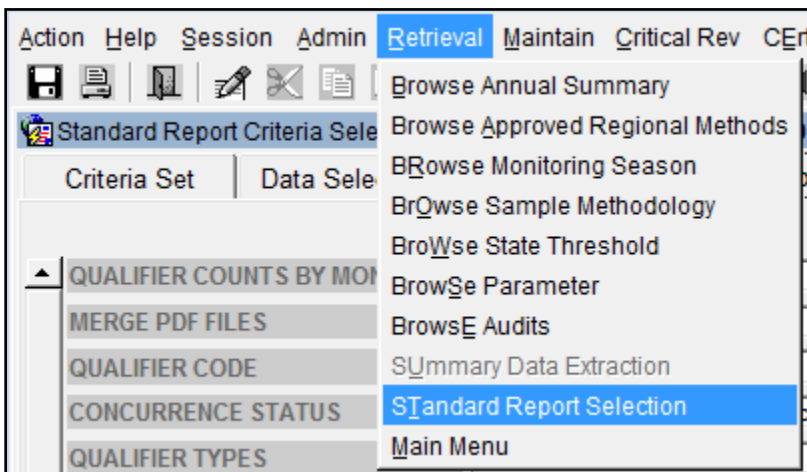

This will open the 'Standard Report Criteria Selection' form.

Standard Report Criteria Selection (National Air Data Group)

Criteria Set | Data Selection | Sort Order | Report Options | Retrieve Reports

Criteria Set: [Dropdown] Desc: [Text Box]

Owner: MICHAEL | BROOKS Type: PRIVATE

Report Code: [Dropdown] Report Name: [Text Box]

Run Online
 Send via Email

Report Outputs

[List of checkboxes]

Generate Report

The user will click the LOV associated with the Report Code field.

Reports

Find %

Rep_Report_Code	Report_Name
AMP410	AIR QUALITY INDEX REPORT
AMP410S	AIR QUALITY SUMMARY REPORT
AMP600	CERTIFICATION EVALUATION AND CONCLU
AMP355	COMBINED SITE SAMPLE VALUES
G74	CR RAW DATA
AMP435	DAILY SUMMARY REPORT
AMP430	DATA COMPLETENESS REPORT
AMP255	DATA QUALITY INDICATOR REPORT
AMP480	DESIGN VALUE REPORT
AMP502	EXTRACT P/A DATA
AMP504	EXTRACT QA DATA
AMP501	EXTRACT RAW DATA
AMP503	EXTRACT SAMPLE BLANK DATA
AMP500	EXTRACT SITE/MONITOR DATA
AMP230	FREQUENCY DISTRIBUTION REPORT
AMP440	MAXIMUM VALUES REPORT
AMP390	MONITOR DESCRIPTION REPORT

Find OK Cancel

This will open a pop-up providing the user with a list of reports to choose from.

Once the user has done this the mode the report will run in needs to be determined.

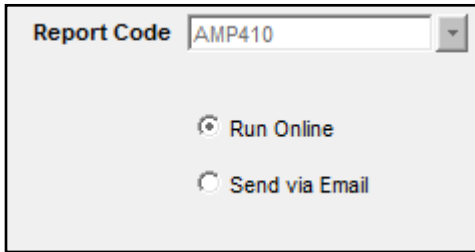

A screenshot of a web form. At the top, there is a label 'Report Code' followed by a text input field containing 'AMP410' and a dropdown arrow. Below this, there are two radio button options: 'Run Online' (which is selected) and 'Send via Email'.

If the user selects 'Run Online' the report will be delivered to the user's browser and the user must stay on-line to retrieve the report.

If 'Send via Email' is selected, AQS will email the report to the address in the user profile. This is called a "batch" report (just like batch load, it can be working while the user is not logged in).

After the user selects a Report Code the Print Format will be show. Also, if the user selected 'Send via Email' then the File Name will be shown.



A screenshot of a web form titled 'Report Outputs'. On the left, there is a list of checkboxes: 'REPORT' (checked), 'WORKFILE', and two unchecked options. On the right, there is a 'Print Format' dropdown menu set to 'PDF' and a 'File Name' text input field.

Output Formats

There are generally two Report Output options available, however there may sometimes be more.

Report

This is a formatted report designed to be read. It is associated with the PDF format.

Workfile

This is a text file of tabular data (with a header) for things like spreadsheets to read. Each AQS report has its own distinct workfile format.

XML

This is a tagged text file of nested data designed for computers to read.

The user may select as many of the Report Outputs as desired. If multiple selections are made, the same data will be sent in different formats.

File Name

If Send via Email was selected the user must give it a short file name in order to have AQS email the report when it is complete.

Data Selection Tab

The screenshot shows a web interface for selecting data criteria. At the top, there are tabs: 'Criteria Set', 'Data Selection' (which is active), 'Sort Order', 'Report Options', and 'Retrieve Reports'. Below the tabs is a large section titled 'Monitor / Geographic Criteria' containing a grid of 11 columns and 10 rows of dropdown menus. The columns are labeled: State Code, County Code, Site Id, Parameter Code, POC, City Code, AQCR Code, UAR Code, CBSA Code, CSA Code, and EPA Region Code. Below this grid are three main sections: 'Protocol Criteria' with dropdowns for Pollutant Type and Parameter Code; 'Date Criteria' with input fields for Start Date and End Date in YYYY MM DD format; and 'Agency Role' with a dropdown menu showing 'PQAO' and an 'Agency' dropdown menu. At the bottom center is a 'Generate Report' button.

The form is divided up into several blocks, each with their own bold header: Monitor/Geographic Criteria, Protocol Criteria, Date Criteria, Monitor Network, and Agency Role. Some blocks may have default values populated depending on the report you have selected.

Each of these blocks allows the user to enter selection criteria for the selected report. Only data that matches criteria will be included in the report. There are a few things to keep in mind when entering selection criteria:

- Certain minimum criteria are required. These vary by report, so the fields are not bolded (like correct and maintain forms). If not have enough criteria have been entered, an error message will be generated.
- The more criteria entered the less data will be returned, and the faster the report will run.

- Entering a criteria means produce those values. Leaving a criteria blank means produce all values.
 - For example, entering a state code will return data for all monitors in the state.
 - Entering a state code and a county code and a parameter code will return data for just that parameter in that county.
 - Entering a pollutant type or parameter code will return data just for it. Leaving it blank will return data for all parameters.

Sort Order Tab

Each report in AQS includes a default sort order (usually the order of display). For some reports, this can be altered using the Sort Order tab. Sort columns can be moved up or down in the sort order by highlighting them and pressing the up or down arrow buttons. Columns may not be added to the sort order.

Report Options Tab

Each report in AQS includes a default set of options that can be changed. To change the options, the user will select different values for the options by using the LOV (drop down) associated with each.

Some reports (with NAAQS related data) will also include some information (that is not adjustable) about which standards will be represented in the data.

Retrieve Reports Tab

This tab keeps a history of recent reports that have been run (going back 30 days). This tab can be used to check on the status of a long-running batch report. It can also be used to download the output of previous reports that may have been misplaced. This is the only way to view an online report after the user has exited the Report Progress popup.

The user will need to refresh this view after opening the Retrieve Reports Tab. The user will click the Refresh Query button to update the view to the latest status.

Note] all reports submitted under the user's name are displayed.

In order to retrieve a report the user can highlight the desired report in the list and then click on the Retrieve Report button.

Any report in the correct state may be stopped from this form. The User will highlight the desired report line and then click the Cancel Report button to cancel the report. The user may find this helpful when a large amount of data has been selected and the report is not needed.

The Delete Report button will delete the selected report. This is not required as the report listing will periodically be cleaned up as a part of routine maintenance.

Note] reports in this list will not remain available for extended periods.

Running a Report

After the report and output options have been chosen and all of the selection criteria (and optionally adjusted the sort order and changed options) have been entered, the report is ready to be run.

Note] every tab on the Standard Reports form (except Retrieve Reports) has a Generate Report button.

After the Generate Report button has been clicked the application may jump back to where the user last had his cursor or to the Criteria Set tab - this is normal.

Report Submitted for Batch Processing

If the report was run in batch mode (emailed to the user when completed), this is the pop-up that will be displayed.

Report Status

If the report was run on-line, the pop-up will display the stage and percent complete of the report. The report can be canceled if an error was made or it is taking too long. When the on-line report is done it will be delivered to the user's browser. If the output is a Report it will appear in a new tab. If the output is a workfile or XML the browser will prompt the user to download a zipped file.

Report Contents

All reports contain a PDF cover page echoing the selection criteria.

If the only output is PDF files, this page will be added to the beginning.

If the output includes non-PDF output, all files will be zipped into a single archive that includes the cover page echoing the selection criteria and one or more files with the results (depending on the report and the outputs). All of the files will begin with the File Name entered on the Criteria Set tab and include suffixes and extensions.

California Dump Bucket

The California Dump Bucket creates an output file that contains any changes to California related data. These changes can come from the AQS batch data load facility (Load, Stat_CR and Post) or from the on-line maintain facilities within AQS. In any case, whenever production-level data related to California is modified, a record is written to the dump bucket table.

This tool exports these modified records to a text file that is used by the California Air Resources Board (CARB). The form queries in the records in the DUMP_BUCKET table and displays them counted and grouped by export date. The displayed fields are Export Date and Record Count.

Form Security

The Export CA Dump Bucket option is only available to AQS users in a Screening Group with a CA_DUMP_USER role.

Form Operation

The user will click on any previously exported date, or click on NOT EXPORTED in the Export Date column.

The user may export all selected records by pressing the appropriate button. The destination choices for exporting these records are Email or Online. Previously exported records can be deleted when the user selects the desired date line and clicks Delete. Not Exported records cannot be deleted.

Output

The output is a text file with the same format as AQS batch input transactions. A record count shows the number of records that were written. The export date in the DUMP_BUCKET table will be updated with the new export date.

Logging Off

AQS can be closed (and logged off) by clicking on either the usual window close button (the red X on the top right for windows users) or the Exit icon.

The user may be asked whether to commit/save changes or exit. The user should answer appropriately.

The user may also exit AQS by closing the browser window that AQS is running in, however it should be noted that this closes AQS without it prompting if the user would like to save any changes

Learn more, service, and support

Refer to the following resources to get more AQS support.

To learn about	Do this
General Use Password Reset Reporting problems	Contact the AQS Help Desk M-F 8am-6:30pm EST 866.411.4372 opt 3 epacallcenter@epa.gov M-F 6am-9pm EST
Loading Data	Go to Loading Data in AQS
Detailed information about data in the database	Go to AQS Data Dictionary
AQS related material	Go to Manuals and Guides
Updating the User's Guide	Contact Mr. Joshua Drukenbrod
User Updates	Go to AQS RSS feed
AQS XML file construction	Go to Exchange Network

Appendix A

Quick Reference Guide

Tips

- Passwords must be changed every 90 days.
- When using reports, be as specific as possible in providing criteria.
- “%” is the wildcard for Oracle queries.
- Date format is: YYYYMMDD
- Under Maintain, if you are logged on in a screening group, you can only access records assigned to your screening group.

Changing Passwords

1. From the Main Menu, click Admin, then Security.
2. Enter new AQS password and Confirm password, click ‘Ok’.

Browse Data

1. From the Main Menu, select Maintain.
2. Select the type of data you want to browse: Site, Monitor, Sample Values (Raw Data)...
3. Enter criteria for limiting the data (For example, state, county, site...).
4. Click the Execute Query button.

Changing Raw Data Values

1. From the Main Menu, click Maintain, Sample Values, and then Raw Data.
2. Enter monitor identifying information, date range, and click Execute Query.
3. Click on field in Raw Data area to change.
4. Change incorrect value.
5. Click Save icon.

Deleting Raw Data Records

1. From the Main Menu, click Maintain, Sample Values, and then Raw Data.
2. Enter monitor identifying information, date range, and click Execute Query.
3. Click on field in Raw Data area to delete.
4. Click Remove Record icon.
5. Click Save icon.

Changing Site/Monitor Data

1. From the Main Menu, click Maintain, then Monitor.
2. Enter Site/Monitor identifying information.
3. Click Execute Query.
4. Make changes.
5. Click Save icon.

Note] changing site data is the same except you would specify Site from the Maintain option.

Using Correct to Change Records in the Staging Tables

1. From the Main Menu, click Correct, then Raw.
2. Enter identifying information, then Execute Query.
3. Correct errors.
4. Click Save icon.
5. Navigate to Batch screen.
6. Click the 'Load File' button.

Uploading Data Using Batch

1. Select Screening Group Access and Screening Group.
2. From the Main Menu, select Batch.
3. Click 'Goto ENSC' and login to the Exchange Network.
4. Click 'My Service Center'.
5. Select the 'Service Name' ending in AQS Submit.
6. Select a Document to Upload.
7. Fill in all other fields and then click 'SEND DATA'
8. After clicking the Send button the 'Request Received!' screen will appear.

Creating Reports

1. From the Main Menu click Retrieval then Standard Reports Selection.
2. Provide Report Code on Criteria Set tab.
3. Choose to run the report online or have it sent via Email.
4. Provide selection criteria on Data Selections tab.
5. If necessary, complete Sort Order and Report Options tabs.
6. Click 'Generate Report' on Criteria Set tab.

Inputting Raw Values Using Maintain

1. From the Main Menu, click Maintain, Sample Values, and then Raw Data.
2. Enter monitor identifying information and then click Execute Query.
3. On Raw Data tab, click on one of the records in the 'Raw Data' area of the screen.
4. Click Insert Record icon in top menu and enter new information.
5. Click the Save icon.

Insert a New Site/Monitor Using Maintain

1. From within Screening Group, click Maintain, and then Site.
2. Click Cancel Query button.
3. On Basic Site Data tab, provide State, County Code, and Site ID.
4. Complete information on Required and Optional tabs of Maintain Site Data screen (Basic Site Data, Agency Roles...).
5. Click Save.
6. Click Create Monitor button.
7. Provide information on Monitor Basic tab as well as other tabs. (Several required fields).
8. Click Save button.
9. Verify that Site & Monitor have been entered by clicking from Main Menu, Maintain, Site and Monitor.
10. Enter State, County, Site ID, and then click Execute Query.
11. Site/Monitor should be displayed.